



Desde
1994
24 sucursales
y contando



CATÁLOGO GENERAL DE PRODUCTOS



UN POCO ACERCA DE NOSOTROS

Fundada en el año de 1994, en Comercializadora Dublín nos hemos dedicado a servir a la industria nacional de la construcción con Herrajes para Vidrio y Aluminio de calidad. Siempre hemos representado prestigiosas marcas de productos que son de gran aceptación en el mercado.



"Crecemos Ayudando a los Demás a Crecer"

Nuestros socios que nos han confiado su marca nos respaldan:

The logo for Olivé, featuring the word "Olivé" in a green, sans-serif font.



The logo for LORFID-BAM, featuring the letters "LB" in a large, stylized, grey font above the text "LORFID-BAM" and "ALUMINIUM ACCESSORIES" in a smaller font.



The logo for CERRADURAS LOK, featuring the word "CERRADURAS" above the letters "L O K" in a large, bold, black font, with a key icon integrated into the letter "O".

The logo for DORTEC, featuring the word "DORTEC" in a bold, black font with a red dot above the letter "D".



The logo for SANBEN, featuring the word "SANBEN" in a bold, white font inside a black rectangular border.

The logo for GCG, featuring the letters "G C G" in a bold, black font.



The logo for MIPT, featuring the letters "MIPT" in a bold, red font above the text "MOST PROFESSIONAL TOOLS" in a smaller font.

The logo for ASSA ABLOY, featuring the word "PHILLIPS" in a red font above a red and white graphic, with "ASSA ABLOY" in a black font below.



The logo for SAINT-GOBAIN NORTON, featuring a stylized grey and white graphic above the text "SAINT-GOBAIN" and "NORTON" in a blue font.

The logo for pabose, featuring a stylized blue and yellow graphic above the word "pabose" in a blue font, with "manufacturas" in a smaller font above.



The logo for DORMA, featuring a stylized red and white graphic above the word "DORMA" in a bold, black font.

The logo for INDUX, featuring the word "INDUX" in a bold, black font inside a black rectangular border.

ÍNDICE

Carretillas

Carretillas Ajustables	01
Carretillas BAM	01
Carretillas de Baño	02
Carretillas de Mosquitero	03
Carretillas Ensamble Rápido	03
Carretillas Importadas	04
Carretillas Línea Española	05
Carretillas Pabose	06
Carretillas para Puerta 2"	07
Carretillas para Vitrina	07

Chapas

Chapa LOK	08
Chapas Borui	10
Chapas Phillips	11
Chapas para Cristal	14

Cintas

Cinta Adhesivas	16
Cinta Multiusos y Calza	16
Cinta Norcryl	16
Cinta Norglaze	16
Cinta Norton	17
Cinta Tapa Goteras	17
Cinta Tipo Norcryl	18
Cinta Tipo Norton	18

Herrajes para aluminio

Balancines	19
Barras de Empuje	19
Barras de Pánico	19

Herrajes para aluminio

Bisagras	20
Brazos	21
Cadena y Candado para Operador	22
Cierrapuertas	23
Cierre Final Eurovent	23
Contra planas	23
Cremallera y ménsulas	24
Escuadras	24
Felpas	26
Fija Puerta	27
Grapas Soporte ancla y Herrajes Sifón	27
Jaladeras	28
Mango Tirador	30
Manijas	30
Mosquitero Enrollable	32
Operadores	33
Pasadores	34
Pivotes	35
Policarbonatos	36
Remaches	36
Resbalones	37
Sellapolvos	37
Tapón de Nylon	37
Taquetes	38
Tela para Mosquitero	38
Topes	39
Uñeros	39
Viniles	40

Herrajes para barandal y acero inoxidable

Herrajes Para Tubo De Barandal ----- 41

Poste para Barandal----- 42

Herrajes para cristal templado

Arañas y Rótulas ----- 44

Bisagras Hidráulicas Y Kits Para Cristal----- 46

Bisagras para Cristal----- 49

Clipos para repisas de cristal----- 51

Conectores y Clips para Cristal ----- 52

Herrajes Maple----- 56

Jaladeras para Cristal Templado----- 57

Herrajes para líneas europeas

1400/2500----- 60

3500----- 61

4600/4000----- 62

Tabla De Productos Para Líneas Españolas----- 65

Herramienta

Brocas ----- 67

Cargadores para Vidrio----- 68

Cortavidrio y Disco ----- 69

Flexómetro ----- 70

Guantes, Garruchas, Garfios----- 70

Cutter Lijas ----- 71

Pistola de Calafateo----- 71

Seguetas ----- 71

MPT ----- 72

Troqueles ----- 73

Película Decorativa

Todas----- 74

Silicones selladores pegamentos

GNS----- 75

Olive ----- 76

Pennsylvania----- 77

Sista ----- 78

Otras Marcas----- 80

Sistemas corredizos y de apertura

Canceles para Baño ----- 81

Sistemas para Puertas Automáticas----- 83

Tornillería

Pijas ----- 84

Tensor ----- 84

Tornillos ----- 84

Varios, misceláneos

Aflojatodo ----- 85

Espuma----- 85

Limpiadores para Aluminio----- 85

Polvo y Piedra de Esmeril----- 86

sal silica ----- 86

Yeso Piedra ----- 86

Carretillas

Carretillas Ajustables

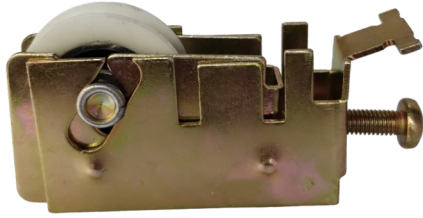

Linea: H122
Clave: CA-1500 LN
Acabados: LATONADA

CARRETILLA AJUSTABLE DE 1-4" 2004
LATONADA RODAJA NYLON



Linea: H122
Clave: CA-1500 RN

CARRETILLA AJUSTABLE DE 1 1-4" RODAJA NYLON



Linea: H122
Clave: CA-1502 N

CARRETILLA AJUSTABLE TANDEM RODAJA 1 1-2" IMPORTADA

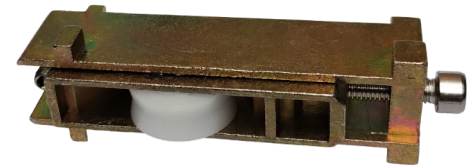

Linea: H163
Clave: CA-0080 S

CARRETILLA REGULABLE DE METAL SERIE 80 SENCILLA

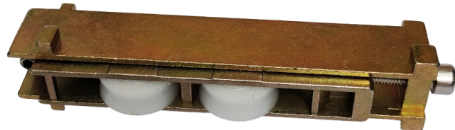

Linea: H163
Clave: CA-0080 T

CARRETILLA REGULABLE DE METAL SERIE 80 TANDEM

Carretillas BAM



Linea: H151
Clave: CA-1510 B

CARRETILLA ESPAÑOLA BAM PARA MOSQUITERO DE NYLON



Linea: H151
Clave: CA-1511 B

CARRETILLA ESPAÑOLA BAM PARA VITRINA

Carretillas

Carretillas BAM



Linea: H151
Clave: CA-1512 B

CARRETILLA ESPAÑOLA BAM SENCILLA 2"



Linea: H151
Clave: CA-1513 B

CARRETILLA ESPAÑOLA BAM DOBLE PARA VENTANA 2"



Linea: H151
Clave: CA-1514 B

CARRETILLA ESPAÑOLA BAM PARA PUERTA DE 2"



Linea: H151
Clave: CA-1515 B

CARRETILLA ESPAÑOLA BAM 3" FIJA



Linea: H151
Clave: CA-1516 B

CARRETILLA ESPAÑOLA BAM TANDEM PARA 3"

Carretillas de Baño



Linea: H126
Clave: CA-1503 E

CARRETILLA PARA BANO RODAJA IMPORTADA



Linea: H126
Clave: CA-1503 EA

CARRETILLA PARA BANO IMPORTADA ALTA

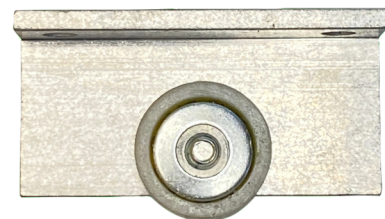

Linea: H126
Clave: CA-1503 RI

CARRETILLA PARA BANO RODAJA IMPORTADA CON TORNILLO

Carretillas

Carretillas de Mosquitero



Linea: H130
Clave: CA-1504 FI

CARRETILLA PARA MOSQUITERO CON FLEJE Y RODAJA IMPORTADA

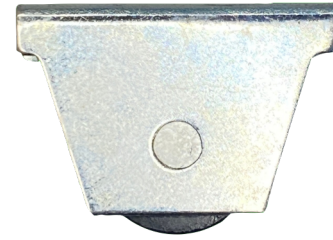

Linea: H130
Clave: CA-1504 NI

CARRETILLA PARA MOSQUITERO RODAJA NYLON IMPORTADA



Linea: H150
Clave: CA-1510 N

CARRETILLA ESPANOLA PARA MOSQUITERO 105-P-M DE NYLON



Linea: H158
Clave: CA-1510 I

CARRETILLA PARA MOSQUITERO DE NYLON IMPORTADA

Carretillas Ensamble Rápido



Linea: H142
Clave: CA-1507 AE

CARRETILLA PARA VENTANA 1 1-2" RODAJA ACERO EMBALADA



Linea: H162
Clave: CA-1521 I

CARRETILLA PARA VENTANA DE 2" ENSAMBLE RAPIDO IMPORTADA

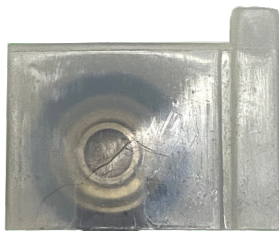

Linea: H162
Clave: CA-1522 I

CARRETILLA PARA PUERTA 2" ENSAMBLE RAPIDO IMPORTADA

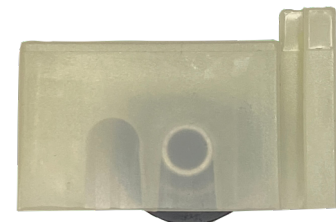

Linea: H162
Clave: CA-1523 RI

CARRETILLA PARA PUERTA DE 3" PULGADAS ENSAMBLE RAPIDO PP REFORZADO RODAJA IMPORTADA

Carretillas

Carretillas Importadas



Linea: H134
Clave: CA-1505 RI

CARRETILLA PUERTA 2" PINTADA RODAJA NYLON IMP EMBALADA



Linea: H158
Clave: CA-1511 I

CARRETILLA PARA VITRINA IMPORTADA



Linea: H158
Clave: CA-1512 I

CARRETILLA DE 2" PARA VENTANA IMPORTADA



Linea: H158
Clave: CA-1513 I

CARRETILLA DE 2" PARA VENTANA DOBLE IMPORTADA



Linea: H158
Clave: CA-1514 I

CARRETILLA DE 2" PARA PUERTA IMPORTADA



Linea: H158
Clave: CA-1515 I

CARRETILLA DE 3" PULGADAS FIJA IMPORTADA



Linea: H158
Clave: CA-1516 I

CARRETILLA DE 3" TANDEM IMPORTADA

Carretillas

Carretillas Linea Española



Linea: H164
Clave: CA-3500 S

CARRETILLA PARA SERIE 3500 SENCILLA



Linea: H164
Clave: CA-3500 T

CARRETILLA PARA SERIE 3500 TANDEM



Linea: H165
Clave: CA-4600 S

CARRETILLA REGULABLE BAM PARA LINEA 4600



Linea: H165
Clave: CA-4600 T

CARRETILLA TANDEM BAM SERIE 4600



Linea: H165
Clave: CA-4600 SP

CARRETILLA REGULABLE DE PLASTICO SERIE 4600



Linea: H165
Clave: CA-4600 TP

CARRETILLA TANDEM DE PLASTICO SERIE 4600

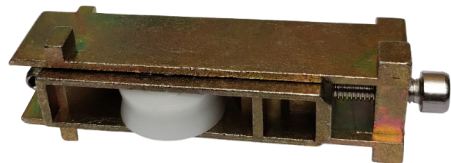

Linea: H163
Clave: CA-0080 S

CARRETILLA REGULABLE DE METAL SERIE 80 SENCILLA

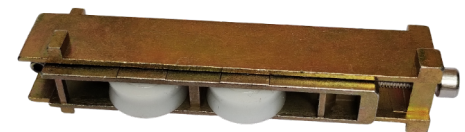

Linea: H163
Clave: CA-0080 T

CARRETILLA REGULABLE DE METAL SERIE 80 TANDEM

Carretillas

Carretillas Pabose



Linea: H150
Clave: CA-1511

CARRETILLA ESPAÑOLA 100V-MI PABOSE PARA VITRINA



Linea: H150
Clave: CA-1512

CARRETILLA ESPANOLA PABOSE SENCILLA 2" 101-1 1-2-M



Linea: H150
Clave: CA-1513

CARRETILLA ESPANOLA T-101-1 1-2-M DOBLE PARA VENTANA DE .2"



Linea: H150
Clave: CA-1514

CARRETILLA PABOSE 102-2 PARA PUERTA DE 2"



Linea: H150
Clave: CA-1515

CARRETILLA ESPAÑOLA 103-3 PABOSE 3" FIJA

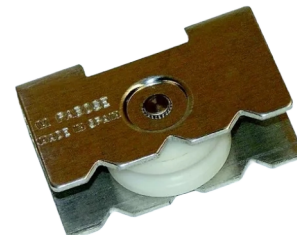

Linea: H150
Clave: CA-1515 A

CARRETILLA PABOSE FIJA 103 3" PULGADAS ALMA ANTICORROSIVA



Linea: H150
Clave: CA-1516

CARRETILLA ESPANOLA PABOSE T-103-3 MI TANDEM PARA 3"



Linea: H150
Clave: CA-1516 A

CARRETILLA ESPANOLA PABOSE TANDEM PARA 3" ANTICORROSIVA

Carretillas

Carretillas Pabose

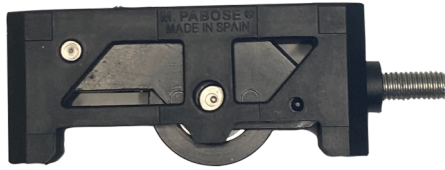

Linea: H150
Clave: CA-1517

CARRETILLA AJUSTABLE GT-25-38P PABOSE

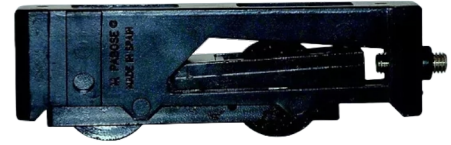

Linea: H150
Clave: CA-1519

CARRETILLA AJUSTABLE GT-103 3\"/>



Linea: H150
Clave: CA-1520 S

CARRETILLA AJUSTABLE G-103E-3\"/>
ALM PABOSE ANTICORROSIVA

Carretillas para Puerta 2"



Linea: H134
Clave: CA-1505 RI

CARRETILLA PUERTA 2\"/>



Linea: H138
Clave: CA-1506 RI

CARRETILLA PARA VENTANA DE 2\"/>

Carretillas para Vitrina

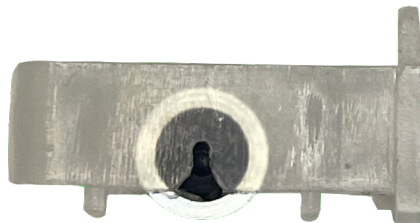

Linea: H146
Clave: CA-1508 NE

CARRETILLA PARA VITRINA RODAJA ACERO EMBALADA



Linea: H158
Clave: CA-1511 I

CARRETILLA PARA VITRINA IMPORTADA

Chapas

Chapa LOK



Linea: H177
Clave: CH-4010 S, LA, O
Acabados: SATIN LATON ANTIGUO ORO

CERRADURA DE BOLA LOK DOBLE LLAVE



Linea: H177
Clave: CH-4020 O S LA
Acabados: ORO, LATON, LATON ANTIGUO, SATIN

CERRADURA DE BOLA LOK PARA BAÑO



Linea: H177
Clave: CH-4000 S
Acabados: SATIN

CERROJO LOK DE SEGURIDAD LLAVE MARIPOSA



Linea: H178
Clave: CH-6010 NG
Acabados: NEGRO, BLANCO, NATURAL, BRONCE BRILLANTE, SATIN

CHAPA LOK DOBLE CILINDRO O CILINDRO MARIPOSA



Linea: H222
Clave: CH-1606 D
Acabados: NEGRO BLANCO NATURAL

CHAPA DE PALETA 590 IMPORTADA



Linea: H301
Clave: CH-1002 BL
Acabados: BLANCO Y NEGRO

CHAPA TIPO TRUTH CON UÑERO Y MANGO LOK

Chapas

Chapas LOK



Linea: H297
Clave: CH-1619 BLI
Acabados: BLANCO NEGRO NATURAL

CHAPA DE GANCHO IMPORTADA. LOK CON TETRA LLAVE



Linea: H296
Clave: BLANCO NEGRO NATURAL
Acabados: CH-1611 BLI

CHAPA DE PALETA IMPORTADA LOK CON TETRA LLAVE



Linea: H298
Clave: CH-1639 NG1
Acabados: NEGRA BLANCO PLATA

CERRADURA LOK DOBLE MANIJA CLAVE DE PUNTO

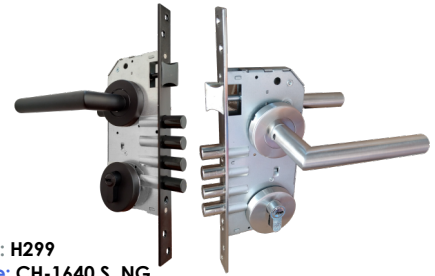

Linea: H299
Clave: CH-1640 S, NG
Acabados: SATIN Y NEGRO

CHAPA DE SEGURIDAD LOK PARA SERIE 50 4 PUNTOS



Linea: H300
Clave: CH-1590 S, LA, NG
Acabados: SATIN, LATON ANTIGUO Y NEGRO

CHAPA GATILLO DOBLE CILINDRO LOK

Chapas

Chapas Borui



Linea: H209
Clave: CH-1505 BL
Acabados: BLANCO DURO NATURAL NEGRO

CHAPA BORUI JALADERA MANIJA



Linea: H263
Clave: CH-1618 CI
Acabados: NATURAL

CHAPA BORUI TIPO CAPFCE RESBALON DOBLE CILINDRO



Linea: H263
Clave: CH-1618 MI
Acabados: NATURAL

CHAPA BORUI TIPO CAPFCE RESBALON CILINDRO-MARIPOSA

Chapas

Chapas Phillips



Linea: H182
Clave: CH-1600 BL
Acabados: BLANCO DURANODICK NATURAL

CHAPA PHILLIPS 430 DE PALETA MARIPOSA INTERIOR



Linea: H186
Clave: CH-1601 N
Acabados: NATURAL BLANCO DURANODIK

CHAPA PHILLIPS 435 DE GANCHO MARIPOSA INTERIOR



Linea: H191
Clave: CH-1602 BL
Acabados: AC, BLANCO, DURO, NATURAL Y NEGRA

CHAPA PHILLIPS 570 DOBLE CILINDRO Y CILINDRO MARIPOSA



Linea: H193
Clave: CH-1604 BL
Acabados: BLANCO, DURO, NEGRO, NATURAL

CHAPA PHILLIPS 550 CH SIN MANIJAS



Linea: H194
Clave: CH-1603 D2
Acabados: BLANCA, DURO, NEGRA, NATURAL

CHAPA PHILLIPS 550 DOBLE MANIJA



Linea: H195
Clave: CH-1617 BL
Acabados: BLANCO, DURANODIK MADERA, NATURAL, NEGRO

CHAPA PHILLIPS 555 DOBLE MANIJA CON MARIPOSA



Linea: H210
Clave: CH-1605 D
Acabados: BLANCO, DURO, NATURAL, NEGRA

CHAPA PHILLIPS 575 JALADERA MANIJA



Linea: H224
Clave: CH-1607 NG
Acabados: NEGRA, BLANCA, NATURAL

CHAPA PHILLIPS 520 DOBLE CILINDRO Y CILINDRO MARIPOSA

Chapas

Chapas Phillips



Linea: H226
Clave: CH-1608 BL
Acabados: BLANCO, DURO, NATURAL, NEGRA

CHAPA PHILLIPS 549 DOBLE CILINDRO MM



Linea: H227
Clave: CH-1608 CN
Acabados: BLANCO, DURO, NATURAL, NEGRA

CHAPA PHILLIPS 549 CILINDRO MARIPOSA MM



Linea: H234
Clave: CH-1609 N
Acabados: BLANCO, DURO Y NATURAL

CHAPA PHILLIPS 3065 DOBLE MANIJA



Linea: H234
Clave: CH-1610 BL
Acabados: BLANCO, DURO, NATURAL

CHAPA PHILLIPS 3065 JALADERA MANIJA



Linea: H237
Clave: CH-1721 C
Acabados: CROMO

CHAPA PHILLIPS MOD.21



Linea: H238
Clave: CH-1608 C
Acabados: CROMO Y LATON

CHAPA PHILLIPS MODELO 200



Linea: H242
Clave: CH-1611 BL
Acabados: BLANCO DURO NEGRO Y NATURAL

CHAPA DE PALETA PHILLIPS X-450 TETRA LLAVE



Linea: H243
Clave: CH-1619 NG
Acabados: NEGRO, BLANCO, DURO, NATURAL

CHAPA DE GANCHO PHILLIPS X-455 TETRA LLAVE

Chapas

Chapas Phillips



Linea: H250
Clave: CH-1614 N
Acabados: NATURAL DURANODIK BLANCA

CHAPA DE PALETA 590 PHILLIPS



Linea: H262
Clave: CH-1618 N
Acabados: NATURAL

CHAPA PHILLIPS 525 CILINDRO MARIPOSA RESBALON



Linea: H262
Clave: CH-1618 N1
Acabados: NATURAL

CHAPA PHILLIPS 525 DE RESBALON DOBLE CILINDRO



Linea: H278
Clave: CH-1622 N
Acabados: BLANCO, DURO Y NATURAL

CHAPA PHILLIPS 425 DOBLE CILINDRO



Linea: H282
Clave: CH-1623 D
Acabados: BLANCO, DURO Y NATURAL

CHAPA PHILLIPS 425 CILINDRO MARIPOSA



Linea: H290
Clave: CH-1628 N
Acabados: BLANCO, DURO Y NATURAL

CHAPA PHILLIPS 3055 ACABADOS



Linea: H330
Clave: CO-1803 C
Acabados: CROMADO

CONTRA ELECTRICA PHILLIPS

Chapas para Cristal



Linea: H035
Clave: CH-1616 AM
Acabados: SATIN

CHAPA DE CENTRO 9CE SIN RESAQUE ALARGADA MARIPOSA



Linea: H035
Clave: CH-1616 C
Acabados: SATIN

CHAPA DE CENTRO 9CE SIN RESAQUE CLASICA



Linea: H035
Clave: CH-1616 CH
Acabados: SATIN

CHAPA DE CENTRO SIN RESAQUE REDONDA CHICA 9CE



Linea: H035
Clave: CH-1616 D
Acabados: SATIN

CHAPA DE CENTRO 9CE SIN RESAQUE REDONDA CILINDRO UNILATERAL



Linea: H035
Clave: CH-1616 DC
Acabados: SATIN

CHAPA DE CENTRO 9CE PARA CRISTAL



Linea: H035
Clave: CH-1616 J
Acabados: SATIN

CHAPA DE CENTRO 9CE CON JALADERA DOBLE LLAVE



Linea: H035
Clave: CH-1616 JM
Acabados: SATIN

CHAPA DE CENTRO DORTEC CON JALADERA LLAVE MARIPOSA

Chapas para Cristal

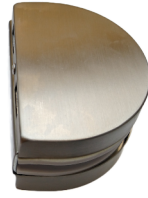

Linea: H035
Clave: CH-1616 R
Acabados: SATIN

CHAPA DE CENTRO 9CE SIN RESAQUE REDONDA MARIPOSA



Linea: H035
Clave: SE-3502 S
Acabados: SATIN

SEGURO 9CE PARA CRISTAL DE 10-12 MM SIN SAQUE



Linea: H035
Clave: CH-1616 DM
Acabados: SATIN

CHAPA DE CENTRO 9CE PARA MURO



Linea: H246
Clave: CH-1613 C

CHAPA PARA VITRINA CROMADA 1100



Linea: H246
Clave: CH-9001 C
Acabados: CROMO

CHAPA IMPORTADA PARA VITRINA CORREDIZA



Linea: H246
Clave: CH-9002 C
Acabados: CROMO

CHAPA IMPORTADA PARA VITRINA ABATIBLE



Linea: H035
Clave: SE-3501 C
Acabados: CROMO

SEGURO PARA CRISTAL DE 10-12MM

Cintas

Cinta Adhesivas



Linea: H308
Clave: CT-1300

CINTA TRANSPARENTE DE EMPAQUE 48X50



Linea: H310
Clave: CM-1500

CINTA MASKING TAPE VARIAS MEDIDAS

Cinta Multiusos y Calza



Linea: H314
Clave: CN-1414

CINTA PENNSYLVANIA MULTIUSOS ROLLO 7.5 MTS



Linea: H313X
Clave: CN-1403

CALZA DE NEOPRENO 1-4 X 3-8 X 4"

Cinta Norcryl y NORGLAZE



Linea: H316
Clave: CN-1420
Acabados: TRANSPARENTE

CINTA NORCRYL A 3210 MEDIDAS 1.01 MM X 1-4" X 33 MTS
Y 1.01 MM 1-2" X 33 MTS

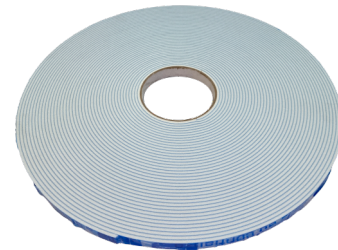

Linea: H317
Clave: CN-1415
Acabados: BLANCA

CINTA NORGLAZE F-9504 MEDIDAS 1-8" X 1-2" Y 1-8" X 3-8"
BLANCO ROLLO DE 25.90 MTS

Cintas

Cinta Norton

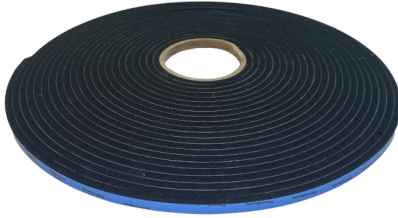

Linea: H314
Clave: CN-1407
Acabados: NEGRO

CINTA NORTON BAJA DENSIDAD (SUAVE) EN VARIAS MEDIDAS EN PULGADAS

Clave	Descripción
-------	-------------

CN-1402	CINTA NORTON 998 - 1/4" X 1/4" ROLLO DE 15.23 MTS.
CN-1404	CINTA NORTON 998 - 1/4" x 1/2" ROLLO DE 15.23 MTS.
CN-1405	CINTA NORTON 998 - 1/4" x 3/8" ROLLO DE 15.23 MTS.
CN-1406	CINTA NORTON 994 - 1/8" X 3/8" ROLLO DE 30.4 MTS.
CN-1407	CINTA NORTON 994 - 1/8" X 1/2" ROLLO DE 30.4 MTS.
CN-1408	CINTA NORTON 994 - 1/8" X 1/4" ROLLO DE 30.4 MTS.



Linea: H315
Clave: CN-1411
Acabados: NEGRO

CINTA NORTON 2208 ALTA DENSIDAD (RÍGIDA)

Clave	Descripción
-------	-------------

CN-1410	CINTA NORTON 2208 - 1/4 X 1/4" ROLLO DE 15.25 MTS.
CN-1411	CINTA NORTON 2208 - 1/4 X 3/8" ROLLO DE 15.25 MTS.
CN-1412	CINTA NORTON 2208 - 1/4 X 1/2" ROLLO DE 15.25 MTS.

Cinta Tapa Goteras



Olivé

Linea: H309
Clave: CT-0010 O
Acabados: SATIN

CINTA TAPAGOTERAS EBANK EK OLIVE 10MTS 50MM



Linea: H309
Clave: CT-0020 G
Acabados: SATIN

CINTA TAPAGOTERAS GNS 10MTS 50MM

Cintas

Cinta Tipo Norcryl

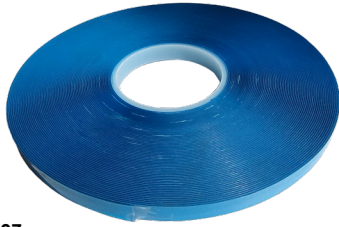

Linea: H307
Clave: CN-1420 I
Acabados: TRANSPARENTE

CINTA TIPO NORCRYL 1.01 MM X 1-4" Y 1-2" X 33 MTS

Cinta Tipo Norton



Linea: H311
Clave: CN-1404 I
Acabados: NEGRO

CINTA TIPO NORTON 998 SUAVE VARIAS MEDIDAS
ROLLO DE 15.23 MTS

Clave	Descripción
-------	-------------

CN-1402 I	CINTA TIPO NORTON 998 - 1/4" X 1/4" ROLLO DE 15.23 MTS.
CN-1404 I	CINTA TIPO NORTON 998 - 1/4" X 1/2" ROLLO DE 15.23 MTS.
CN-1405 I	CINTA TIPO NORTON 998 - 1/4" X 3/8" ROLLO DE 15.23 MTS.
CN-1406 I	CINTA TIPO NORTON 994 - 1/8" X 3/8" ROLLO DE 30.4 MTS.
CN-1407 I	CINTA TIPO NORTON 994 - 1/8" X 1/2" ROLLO DE 30.4 MTS.
CN-1408 I	CINTA TIPO NORTON 994 - 1/8" X 1/4" ROLLO DE 30.4 MTS.X



Linea: H312
Clave: CN-1410 I
Acabados: NEGRO

CINTA TIPO NORTON 2208 DURA VARIAS MEDIDAS
ROLLO DE 15.25 MTS

Clave	Descripción
-------	-------------

CN-1410 I	CINTA TIPO NORTON 2208 - 1/4 X 1/4" ROLLO DE 15.25 MTS.
CN-1411 I	CINTA TIPO NORTON 2208 - 1/4 X 3/8" ROLLO DE 15.25 MTS.
CN-1412 I	CINTA TIPO NORTON 2208 - 1/4 X 1/2" ROLLO DE 15.25 MTS.

Herrajes para aluminio

Balancines



Linea: H006
Clave: BA-1012

BALANCIN PARA GUILLOTINA MEDIDAS
EN PULGADAS 12" 14" 17" 20" 24" 28" 30"



Linea: H006
Clave: BA-1000 BR

BRACKET SUELTO PARA BALANCIN

Barras de Empuje



Linea: H010
Clave: BA-1100 D
Acabados: BLANCO NEGRO Y NATURAL

BARRA DE EMPUJE DE LUJO DE 1.20 MTS.



Linea: H010
Clave: BA-1101 BL
Acabados: BLANCO NEGRO NATURAL

BARRA DE EMPUJE DE BASTON DE 1.20 MTS.

Barras de Pánico



Linea: H014
Clave: BA-1102 H
Acabados: ROJO CON NEGRO, Y NATURAL

BARRA DE PANICO HORIZONTAL
TIPO EUROPEA DE 1.20 MTS. DORTEC

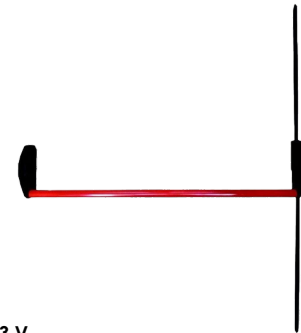

Linea: H014
Clave: BA-1103 V
Acabados: ROJO CON NEGRO, Y NATURAL

BARRA DE PANICO VERTICAL TIPO EUROPEA

Bisagras



Linea: H049
Clave: BE-1200 PL
Acabados: BLANCO, NEGRO Y PLATA

BISAGRA EUROVENT ESPAÑOLA BAM GB-113



Linea: H050
Clave: BE-1201 PL
Acabados: BLANCO, NEGRO Y PLATA

BISAGRA EUROVENT ESPAÑOLA BAM GB-147



Linea: H051
Clave: BE-1400 2BL
Acabados: BLANCO NEGRO PLATA

BISAGRA EUROPEA BAM DE 2 PALAS INVERTIBLE PARA SERIE 1400 Y 6000



Linea: H051
Clave: BE-1400 3D
Acabados: BLANCO NEGRO Y PLATA

BISAGRA EUROPEA BAM DE 3 PALAS INVERTIBLE SERIES 1400 Y 6000



Linea: H075
Clave: BL-1200 CBL
Acabados: BLANCA NEGRO NATURAL

BISAGRA DE LIBRO OCTAGONAL

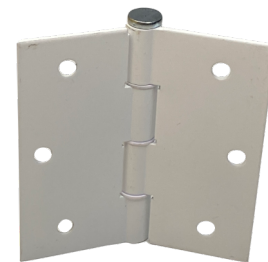

Linea: H070
Clave: BL-1200 BL
Acabados: BLANCO, BRONCE BR, CHAMPAGNE, DURO, G2, NATURAL, ORO Y MADERA

BISAGRA DE LIBRO 3 X 3



Linea: H074
Clave: BL-1201 PLI
Acabados: BLANCO, DURO Y NATURAL

BISAGRA IMPORTADA DE 2" X 2"

Bisagras y Brazos

Bisagras



Linea: H078
Clave: BL-1200 PN
Acabados: BLANCO NEGRO DURANODIK Y NATURAL

BISAGRA DE LIBRO PHILLIPS



Linea: H090
Clave: BP-1200 BL
Acabados: BLANCO, BRONCE BR, CHAMPAGNE DURO, NATURAL Y ORO

BISAGRA DE PIANO DE 1.90 MTS.

Brazos



Linea: H098
Clave: BR-1312 I
Material: GALVANIZADO

BRAZO PARA VENTILA DE PROYECCION IMPORTADO
MEDIDAS 8" 12", 16" 20"



Linea: H101
Clave: BR-1400 A
Material: Acero Inox

BRAZO AJUSTADOR ESPAÑOL BAM



Linea: H102
Clave: BR-1400
Material: ACERO INOXIDABLE

BRAZO AJUSTADOR DE 10 INGLES I



Linea: H102
Clave: BR-1408
Material: ACERO INOXIDABLE

BRAZO INGLES PARA VENTILA DE PROYECCION
MEDIDAS 8" 12" 16" 20" 24"



Linea: H106
Clave: BR-1400 I
Material: ACERO INOXIDABLE

BRAZO IMPORTADO FRICCIONANTE AJUSTADOR 10

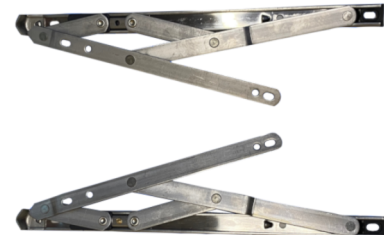

Linea: H106
Clave: BR-1408 I
Material: ACERO INOXIDABLE

BRAZO TIPO INGLES MEDIDAS 8" 12" 16" 20"

Cadena y Candado para Operador



Linea: H166
Clave: CD-1400

CADENA FASETADA PARA OPERADOR DE 4.5 MM ROLLO



Linea: H166
Clave: CN-1400

CANDADO PARA CADENA DE OPERADOR

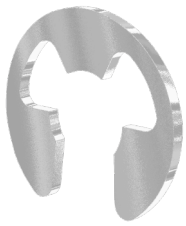

Linea: H166
Clave: CN-1401

CANDADO PARA OPERADOR DE PALANCA

Cierrapuertas, Cierre Final, contraplanas

Cierrapuertas



Linea: H338
Clave: CP-1700 D
Acabados: DURANODIC NATURAL

CIERRAPUERTA PARA MOSQUITERO E-200



Linea: H341
Clave: CP-1700 NI
Acabados: NATURAL Y NEGRO

CIERRAPUERTA PARA MOSQUITERO PARA 30 KG



Linea: H342
Clave: CP-1701 D
Acabados: NEGRO BLANCO NATURAL GRIS

CIERRAPUERTAS DORTEC 63-2



Linea: H346
Clave: CP-1702 BL
Acabados: BLANCO DURANODIK NATURAL

CIERRAPUERTA HID.DORMA TS COMPAK 80 KG

Cierre Final Eurovent



Linea: H174
Clave: CF-1400 BL, N, NA
Acabados: BLANCO NEGRO NATURAL

CIERRE FINAL EUROVENT

Contraplanas



Linea: H318
Clave: CO-1800 BL
Acabados: BLANCA NEGRO NATURAL
ORO BRONCE CHAMPAGNE

CONTRAPLANA DE 12 CMS. PARA MOSQUITERO



Linea: H322
Clave: CO-1801 D
Acabados: NEGRO, BLANCO, NATURAL,
ORO, BRONCE, CHAMPAGNE

CONTRAPLANA DE 18 CMS. PARA MOSQUITERO

Cremallera, ménsulas, Escuadras

Cremallera, ménsulas



Linea: H350
Clave: CR-1901 D
Acabados: NEGRO NATURAL BLANCA

CREMALLERA MEDIDAS DE 1.20 Y 1.80 MTS.

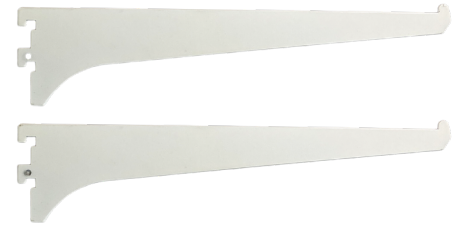

Linea: H546
Clave: ME-2400 BL
Acabados: BLANCA NEGRO NATURAL ORO

MENSULA DE 15 20 25 30 CMS.

Escuadras

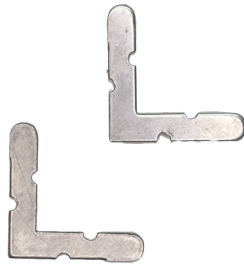

Linea: H369
Clave: ES-2000

ESCUADRA PARA MOSQUITERO

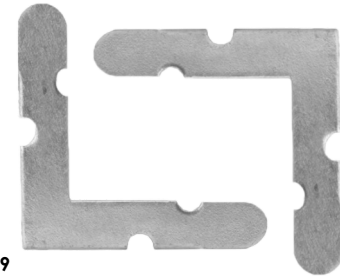

Linea: H369
Clave: ES-2000 A

ESCUADRA PARA MOSQUITERO DE ALUMINIO



Linea: H370
Clave: ES-2000 E

ESCUADRA DE ALUMINIO PARA BAÑO ECONOMICO



Linea: H370
Clave: ES-2000 L

ESCUADRA DE ALUMINIO PARA BAÑO DE LUJO

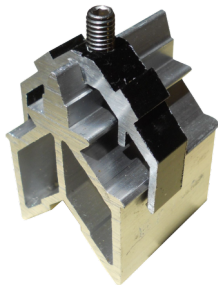

Linea: H372
Clave: EP-1400

ESCUADRA PARA PUERTA SERIE 1400



Linea: H372
Clave: ES-0417

ESCUADRA PARA LINEA ESPAÑOLA 0417 MONTICELLI



Escuadras



Linea: H372
Clave: ES-0421

ESCUADRA PARA LINEA ESPAÑOLA 0421 MONTICELLI

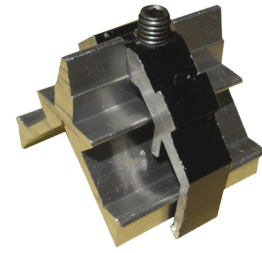

Linea: H372
Clave: ES-3500

ESCUADRA PARA SERIE 3500

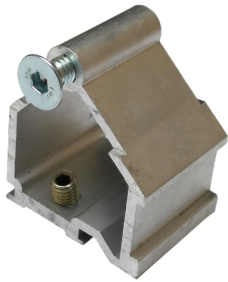

Linea: H372
Clave: EU-1400 P

ESCUADRA UNION PILASTRA PUERTA 1400

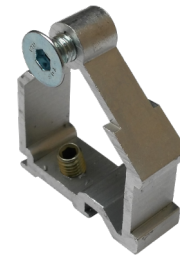

Linea: H372
Clave: EU-1400 V

ESCUADRA UNION PILASTRA VENTANA 1400

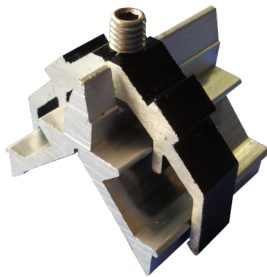

Linea: H372
Clave: EV-1400

ESCUADRA PARA VENTANA SERIE 1400

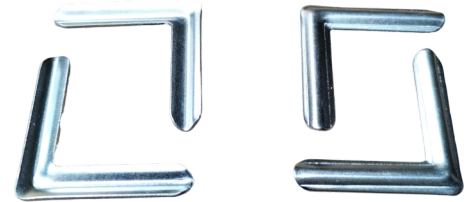

Linea: H373
Clave: ES-4600 A

ESCUADRA DE ALINEACION PARA SERIE 4600

Escuadras, Felpas

Escuadras



Linea: H373
Clave: ES-4600 CF

ESCUADRA ESPAÑOLA CERCO Y FIJO SERIE 4600



Linea: H373
Clave: ES-4600 CT

ESCUADRA ESPAÑOLA CERCO TRES RIELES SERIE 4600



Linea: H373
Clave: ES-4600 H

ESCUADRA ESPAÑOLA HOJA SERIE 4600

Felpas



Linea: H382
Clave: FE-2103 G
Acabados: GRIS NEGRO BLANCO

FELPA IMPORTADA POR ROLLO 200 MTS



Linea: H383
Clave: FE-2106 BL
Acabados: BLANCO GRIS NEGRO

FELPA IMPORTADA DE 7 X 11 200 MTS FELPON



Linea: H384
Clave: FE-4600 N
Acabados: GRIS, NEGRO

FELPA LINEA 4600 IMPORTADA POR ROLLO 350 MTS

Fija Puerta, Grapas Soporte ancla y Herrajes Sifón

Fija Puerta



Linea: H390
Clave: FP-2200 NA, C, N, BL
Acabados: BLANCO CROMO NEGRO NATURAL

FIJA PUERTA PATA DE CABRA

Grapas Soporte ancla y Herrajes Sifón

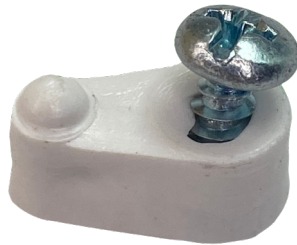

Linea: H398
Clave: GN-154
Acabados: BLANCO Y NEGRO

GRAPA PARA MOSQUITERO GB-154

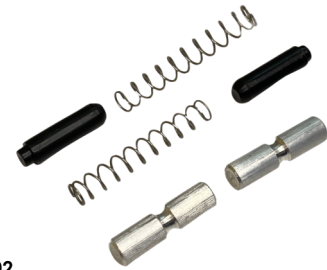

Linea: H402
Clave: HS-1611

HERRAJES PARA VENTANA SIFON

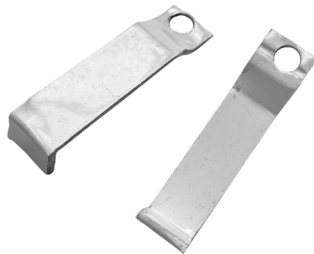

Linea: H778
Clave: SO-3500 BL
Acabados: BLANCO, DURO, NATURAL Y ORO

SOPORTE PARA MOSQUITERO

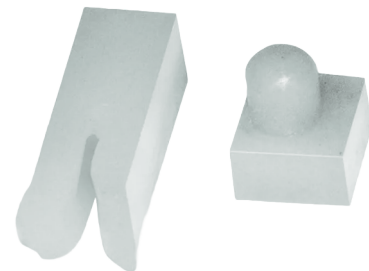

Linea: H790
Clave: TA-4000

TOPE Y ANCLA PARA VENTANA DE 1 1/2

Jaladeras



Linea: H406
Clave: JA-2200 D
Acabados: BLANCO, NEGRO Y NATURAL

JALADERA PARA VENTANA DE 1 1/2 PINTADA



Linea: H410
Clave: JA-2201 BL - JA-2202 D
Acabados: BLANCO, BRONCE BR, CHAMPAGNE, NEGRO G2, NATURAL Y ORO

JALADERA DE 12 O 18 CMS. PARA VENTANA



Linea: H414
Clave: JA-2201 EN - JA-2202 EBL
Acabados: BLANCO, BRONCE , NEGRO, G2, NATURAL Y ORO

JALADERA DE GANCHO ESTRIADA DE 12 O 18 CENTIMETROS PARA VENTANA



Linea: H430
Clave: JA-2205 N
Acabados: NATURAL, BLANCO, BRONCE BR, CHAMPAGNE, NEGRO, G2, ORO Y MADERA

JALADERA TROMPA DE ELEFANTE



Linea: H438
Clave: JA-2209 D
Acabados: DURANODIK, BLANCO, NATURAL,

JALADERA DE LUJO IMPORTADA CON CHAPA



Linea: H450
Clave: JA-2213 C
Acabados: CRISTAL Y GRIS

JALADERA AUTOADHERIBLE PARA VITRINA



Linea: H462
Clave: JA-2216 N
Acabados: NEGRA, BLACO, PLATA

JALADERA PARA 3" PULGADAS BAM ESPANOLA F-304



Linea: H463
Clave: JA-2220 BL
Acabados: BLANCA, NEGRA, PLATA

JALADERA PARA 2 PULGADAS BAM ESPANOLA F-301

Jaladeras



GCG

Linea: H470
Clave: JA-2230 BL1
Acabados: BLANCO, NEGRO, PLATA

JALADERA DE EMBUTIR IMPORTADA PARA 2" PULGADAS



LB
LORFID-BAM
ALUMINIUM ACCESSORIES

Linea: H476
Clave: JA-3500 BL
Acabados: COLORES BLANCA NEGRO PLATA

JALADERA BAM DE EMBUTIR SERIE 3500



LB
LORFID-BAM
ALUMINIUM ACCESSORIES

Linea: H477
Clave: JA-4600 N
Acabados: NEGRA BLANCO PLATA

JALADERA DE EMBUTIR BAM SERIE 4600 CON TORNILLO F-303



GCG

Linea: H478
Clave: JA-2231 PL1
Acabados: PLATA NEGRO BLANCO

JALADERA DE EMBUTIR IMPORTADA PARA 3" PULGADAS



LB
LORFID-BAM
ALUMINIUM ACCESSORIES

Linea: H488
Clave: JA-2040 N
Acabados: NEGRO BLANCO PLATA

JALADERA DE EMBUTIR CON CERRADURA EXTERIOR



Linea: H490
Clave: JA-3333 NG
Acabados: BLANCO, NEGRO, NATURAL Y MADERA

JALADERA 2da.GENERACION DE 10 CMS Y 15 CMS



Linea: H451
Clave: JA-2206 BL
Acabados: BLANCA, NEGRO, NATURAL,

JALADERA MULTIUSOS PARA BAÑO, MOSQUITERO CONPLANA IMPORTADA DE PLASTICO

Mango Tirador, Manijas

Mango Tirador



GCG

Linea: H558
Clave: MG-2401 N
Acabados: NEGRO, BLANCO, NATURAL

MANGO DE ALUMINIO IMPORTADO DE UNA SOLA PIEZA



GCG

Linea: H559
Clave: MG-2402 BL
Acabados: BLANCO, NEGRO, NATURAL

MANGO DE ALUMINIO IMPORTADO



Linea: H560
Clave: MG-4600 BL
Acabados: BLANCO, NEGRO, PLATA

MANGO ADAPTAPTABLE BAM SERIE 4600

Manijas



GCG

Linea: H538
Clave: MA-2305 N1
Acabados: BLANCA, NEGRO, PLATA

MANIJA INVERTIBLE IMPORTADA



GCG

Linea: H526
Clave: MA-2304 BLI
Acabados: BLANCO, NEGRO,, NATURAL

MANIJA INVERTIBLE IMPORTADA

Manijas



Linea: H539
Clave: MA-2306 PL1
Acabados: NATURAL, BLANCO, CHAMPAGNE, NEGRO

MANIJA INVERTIBLE TIPO ESPAÑOLA IMPORTADA



Linea: H061
Clave: MA-2311 BL
Acabados: BLANCA Y NEGRA

MANILLA PARA MULTIPUNTO CON LLAVE

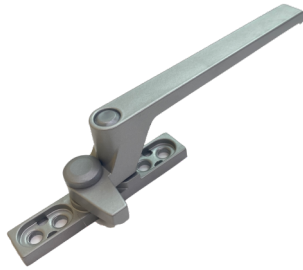

Linea: H542
Clave: MA-2308 N
Acabados: BLANCO, DURO, NATURAL

MANIJA IMPORTADA TIPO INGLESA PARA VENTILA DE PROYECCION



Linea: H061
Clave: MA-2309 NG
Acabados: NEGRA, BLANCA, PLATA

MANILLA RECTA ESPAÑOLA BAM PARA MULTIPUNTO



MOSQUITERO ENROLLABLE

Los mosquiteros enrollables son la solución más práctica y cómoda para proteger su hogar de moscas, mosquitos y todo tipo de insectos.



Materiales:

Marcos y guías en aluminio

Acabados: BLANCO NEGRO GRIS

Malla en fibra de vidrio de alta calidad, cubierta de PVC lavable resistente a los rayos UV y a la abrasión.

Medidas Maximas :

1.60m (ancho) x2.40m (altura)

FÁCIL MONTAJE



Operadores



Linea: H578
Clave: OP-2501 D
Acabados: BLANCO, DURO, NATURAL Y ORO

OPERADOR DE CADENA



Linea: H582
Clave: OP-2503 D
Acabados: BLANCO, DURO, NEGRO, NATURAL Y ORO

OPERADOR DE MANIVELA PHILLIPS



Linea: H583
Clave: OP-2505 BL
Acabados: BLANCO, DURANODICK, NATURAL

OPERADOR DE MARIPOSA PHILLIPS



Linea: H590
Clave: OP-2504 N
Acabados: BLANCO, DURO Y NATURAL

OPERADOR DE MANIV. BRAZO LARGO DERECHO E IZQUIERDO

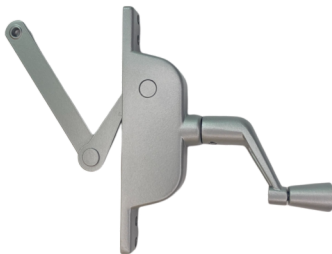

Linea: H597
Clave: OP-2508 N
Acabados: NATURAL, BLANCO, NEGRO

OPERADOR DE MANIVELA IMPORTADO



Linea: H598
Clave: OP-2509 BL
Acabados: BLANCO, NEGRO, NATURAL

OPERADOR DE MARIPOSA IMPORTADO



Linea: H606
Clave: OP-2507 BL
Acabados: BRONCE BR, BLANCO, DURO, NATURAL, Y ORO

OPERADOR DE PALANCA DERECHO E IZQUIERDO

Pasadores



Linea: H609
Clave: PA-4600 BL
Acabados: BLANCO, NEGRO, PLATA, CHAMPAGNE

PASADOR PLANO BAM SERIE 4600

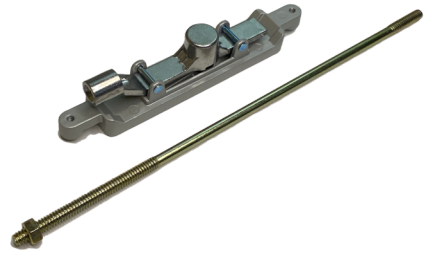

Linea: H610
Clave: PA-2601 N
Acabados: BLANCO, NEGRO, NATURAL

PASADOR DE MAROMA IMPORTADO



Linea: H611
Clave: PA-2604 BL, D
Acabados: BLANCO, DURO, Y NATURAL

PASADOR DE MAROMA MAPLE DE SOBREPONER



Linea: H614
Clave: PA-2602 C
Acabados: CROMO

PASADOR DE SOBREPONER PHILLIPS DE 5 Y 10 CMS



Linea: H625
Clave: PA-2610 EN
Acabados: NATURAL, BLANCO, NEGRO

PASADOR ECONOMICO PARA BAÑO

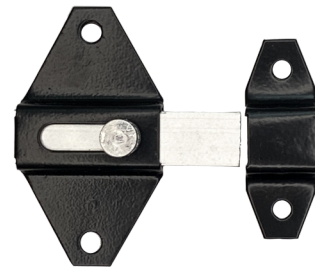

Linea: H626
Clave: PA-2609
Acabados: BLANCO, NEGRO, NATURAL

PASADOR DE ROMBO

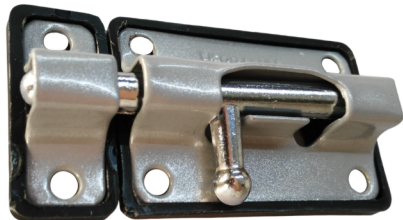

Linea: H627
Clave: PA-2610
Acabados: BLANCO, BRONCE, NATURAL, NEGRO, ORO

PASADOR ECONOMICO PARA BAÑO NACIONAL

Pasadores, Pivotes

Pasadores



Linea: H628
Clave: PA-0010 BL
Acabados: BLANCO NATURAL NEGRO

PASADOR IMPORTADO PARA BAÑO DE 5 Y 10 CMS.

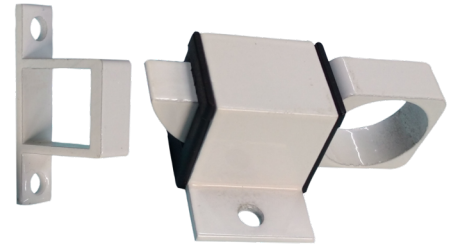

Linea: H629
Clave: PA-2605 BL, N, PL
Acabados: BLANCO, NEGRO, PLATA

PASADOR CON RESBALON IMPORTADO BORUI

Pivotes



Linea: H658
Clave: PV-2900 D
Acabados: NEGRO, BLANCO, NATURAL, ORO, BRONCE

PIVOTE DESCENTRADO REFORZADO



Linea: H662
Clave: PV-2900 Z
Material: ZAMAC

PIVOTE CENTRADO REFORZADO ZAMAC



Linea: H662
Clave: PV-2900 ZA
Material: ALUMINIO

PIVOTE CENTRADO REFORZADO



Linea: H665
Clave: PV-2901 MN
Acabados: NATURAL, BLANCO, NEGRO

PIVOTE DESCENTRADO REFORZADO MAPLE



Policarbonatos, Remaches y Remachadora

Policarbonatos

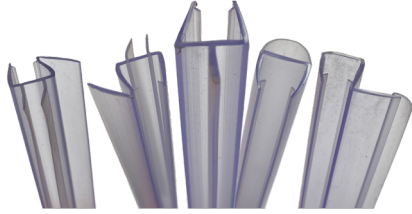

Linea: H822

PERFILES DE POLICARBONATO 2.50MT

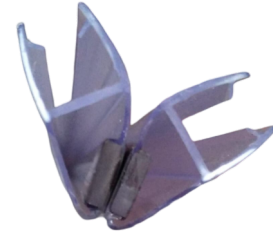

Linea: H826

Clave: VI-WG8-9 M

PERFIL DE POLICARB IMPORTADO MAGNETICO DE 90 GRADOS
9MM LARGO DE 2.50MT

Remaches y Remachadora



Linea: H674

Clave: RE-3104 BL

Acabados: BLANCO, BRONCE, CHAMPAGNE, NEGRO,
MADERA, NATURAL, ORO

REMACHE IMPORTADO VARIOS COLORES Y VARIAS MEDIDAS:
#42, #43, #44, #45, #46 Y #54, #56

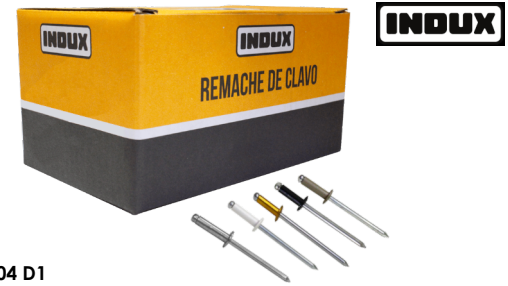

Linea: H678

Clave: RE-3104 D1

Acabados: NATURAL, BLANCO, NEGRO, ORO, BRONCE,
CHAMPAGNE, MADERA

REMACHE INDUX VARIOS COLORES Y VARIAS MEDIDAS:
#42, #43, #44, #45, #46 Y #54, #56



Linea: H682

Clave: RM-3000 T

REMACHADORA DE TRES BOQUILLAS IMPORTADA

Resbalones, Sellapolvos

Resbalones



Linea: H686
Clave: RS-3200
Acabados: BLANCO, NEGRO

RESBALON REFORZADO PARA BAÑO DE NYLON Y CROMO,



Linea: H690
Clave: RS-3202 B

RESBALON DE BALIN



Linea: H690
Clave: RS-3202 B8

RESBALON DE BALIN 8 Y 11 MM

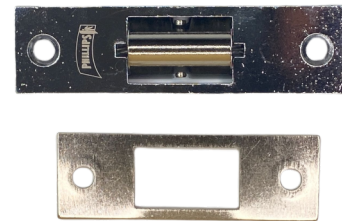

Linea: H694
Clave: RS-3202 C
Acabados: CROMADO

RESBALON CIERRE FRICCION PHILLIPS
TAMAÑO CHICO Y GRANDE

Sellapolvos



Linea: H702
Clave: SE-3400 N
Acabados: NATURAL, BLANCO, NEGRO, ORO, BRONCE

SELLAPOLVO AUTOMATICO MEDIDAS DE 0.90 1.00 Y 1.20 MT



Linea: H706
Clave: SE-3403 BL
Acabados: BLANCO, NEGRO, NATURAL, ORO

SELLAPOLVO SENCILLO MEDIDAS 1.00 MT Y 1.20 MT

Tapón de Nylon



Linea: H806
Clave: TP-3600
Acabados: BLANCO, GRIS, NEGRO

TAPON NYLON DE 3/8

Taquetes, Tela para Mosquitero

Taquetes



Linea: H786
Clave: TA-3702

TAQUETE DE PLASTICO SIN MARCA 1/4



Linea: H786
Clave: TA-3704

TAQUETE DE PLASTICO ZAKANY 1/4



Linea: H786
Clave: TA-3708
Acabados: GRIS

TAQUETE DE PLASTICO ANKER 1/4 CORTO



Linea: H787
Clave: TA-3810

TAQUETE EXPANSIVO 3-8 x 60MM

Tela para Mosquitero



Linea: H794
Clave: TE-3802 N, G,
Acabados: NEGRO Y GRIS

TELA PARA MOSQUITERO DE FIBRA DE VIDRIO VARIAS MEDIDAS
0.60, 0.75, 0.90, 1.05, 1.20, 1.50, 1.80 Y 2.30 MTS

Topes, Uñeros

Topes



Linea: H790
Clave: TA-4001 C, L
Acabados: CROMO, LATON

TOPES DE PISO MOD 56



Linea: H790
Clave: TA-4002 S, C
Acabados: SATIN, CROMO

TOPE DE PISO MOD. 54 SATIN CATARINA



Linea: H790
Clave: TA-4005 C
Acabados: CROMO

TOPE DE PISO PHILLIPS MAGNETICO



Linea: H790
Clave: TA-5010 S
Acabados: SATIN Material: ACERO INOX 304

TOPE PARA PUERTA DE CRISTAL DE 30X40 MM

Uñeros



Linea: H505
Clave: JA-2236 PL
Acabados: BLANCO, NEGRO, PLATA

UÑERO A PRESION ESPAÑOL BAM



Linea: H505
Clave: JA-2238 NG
Acabados: NEGRO, PLATA, BLANCO

UÑERO EMBUTIDO BAM



Linea: H506
Clave: JA-2237 BL
Acabados: BLANCO, NEGRO, PLATA

UÑERO SOBREPUESTO BAM



Linea: H506
Clave: JA-2238 PL1
Acabados: PLATA BLANCO NEGRO

UÑERO EMBUTIDO DOBLE BAM ESPAÑOL

Viniles



Linea: H814
Clave: VI-5011 N
Acabados: NEGRO, BLANCO CRISTAL, Y GRIS

VINIL PENNSYLVANIA CUÑA Y PATA DE COCHINO
VARIAS MEDIDAS



Linea: H818
Clave: VI-0010 N
Acabados: NEGRO, BLANCO, GRIS, Y CRISTAL

VINIL MAPLE CUÑA Y PATA VARIAS MEDIDAS Y COLORES

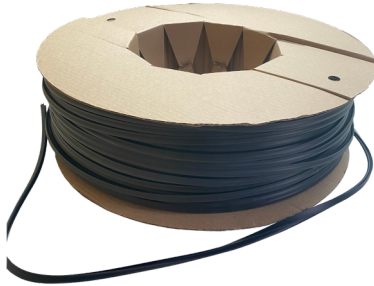

Linea: H819
Clave: VI-1400 N
Acabados: NEGRO

VINIL BASE RIGIDA MAPLE PARA SERIE 1400 ROLLO 200 MT



Linea: H819
Clave: VI-1400 R
Acabados: NEGRO

VINIL GOMA RESPALDO MAPLE ROLLO 200 MT

Herrajes Para Tubo De Barandal



Linea: H004
Clave: BD-1020 IS
Acabados: SATIN Material: ACERO INOXIDABLE 304

CONECTOR CON TAPA PARA TUBO DE 2 PULGADAS



Linea: H004
Clave: BD-1022 IS
Acabados: SATIN Material: ACERO INOXIDABLE 304

CONECTOR SIN TAPA PARA TUBO DE 2 PULGADAS



Linea: H004
Clave: BT-1040 IS
Acabados: SATIN Material: ACERO INOXIDABLE 304

CONECTOR TUBO-TUBO AJUSTABLE PARA TUBO DE 2 PULGADAS



Linea: H004
Clave: BT-1070 IS
Acabados: SATIN Material: ACERO INOXIDABLE 304

CONECTOR DE TUBO EN "T" A PARA TUBO DE 2 PULGADAS



Linea: H004
Clave: BT-1080 IS
Acabados: SATIN Material: ACERO INOXIDABLE 304

CONECTOR TUBO-TUBO 180° PARA TUBO DE 2 PULGADAS



Linea: H004
Clave: BT-1090 IS
Acabados: SATIN Material: ACERO INOXIDABLE 304

CONECTOR TUBO-TUBO 90° PARA TUBO DE 2 PULGADAS



Linea: H004
Clave: SO-8020 T
Acabados: SATIN Material: ACERO INOXIDABLE 304

SOPORTE PARA BARANDAL TUBO A PASAMANO
TUBO DE 2 PULGADAS

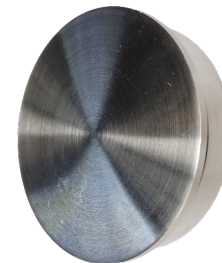

Linea: H004
Clave: TA-8010 T
Acabados: SATIN Material: ACERO INOXIDABLE 304

TAPA PARA TUBO DE 2 PULGADAS

Poste para Barandal



Linea: H015
Clave: BE-1100 C
Acabados: SATIN Material: ACERO INOXIDABLE

BARRA ESTABILIZADORA CRISTAL-CRISTAL DE 1.20 MTS



Linea: H015
Clave: BE-1100 M
Acabados: SATIN Material: ACERO INOXIDABLE

BARRA ESTABILIZADORA MURO-CRISTAL DE 1.20MTS



Linea: H018
Clave: PD-1115 NG
Acabados: NEGRO

MINIPOSTE REDONDO PARA BARANDAL 9CE DE 25CM

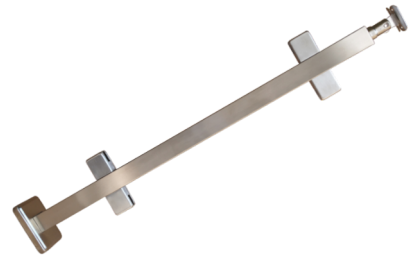

Linea: H028
Clave: PD-1112 D
Acabados: SATIN Material: ACERO INOXIDABLE

POSTE PARA BARANDAL 9CE DOBLE DE 5.1 X85 CM



Linea: H028
Clave: PD-1112 E
Acabados: SATIN Material: ACERO INOXIDABLE

POSTE PARA BARANDAL 9CE ESQUINA 90° DE 5.1 X85 CM



Linea: H028
Clave: PD-1112 S
Acabados: SATIN Material: ACERO INOXIDABLE

POSTE PARA BARANDAL 9CE SENCILLO DE 5.1 X85 CM



Linea: H028
Clave: PD-1112 RD
Acabados: SATIN Material: ACERO INOXIDABLE

POSTE REDONDO PARA BARANDAL 9CE DOBLE



Linea: H028
Clave: PD-1112 RE
Acabados: SATIN Material: ACERO INOXIDABLE

POSTE REDONDO PARA BARANDAL 9CE ESQUINA 90 GRADOS

Poste para Barandal



Linea: H028
Clave: PD-1112 RS
Acabados: SATIN Material: ACERO INOXIDABLE

POSTE REDONDO PARA BARANDAL 9CE SENCILLO



Linea: H028
Clave: PD-1115 S
Acabados: SATIN Material: ACERO INOXIDABLE

MINIPOSTE REDONDO PARA BARANDAL 9CE DE 25CM



Linea: H028
Clave: PD-1117 S
Acabados: SATIN Y NEGRO Material: ACERO INOXIDABLE

MINIPOSTE CUADRADO PBARANDAL SIN PERFORACION 9CE



Linea: H028
Clave: SO-1000 C
Acabados: SATIN Material: ACERO INOXIDABLE

SOPORTE PARA BARANDAL CRISTAL A PASAMANO



Linea: H028
Clave: SO-1000 M
Acabados: SATIN Material: ACERO INOXIDABLE

SOPORTE PARA BARANDAL MURO A PASAMANO

Arañas y Rótulas



Linea: H002
Clave: AR-0001
Acabados: SATIN Material: ACERO INOXIDABLE 304

ARAÑA INSTALACION A VIGA 1 PATA F204-1-90



Linea: H002
Clave: AR-0002
Acabados: SATIN Material: ACERO INOXIDABLE 304

ARAÑA INSTALACION A VIGA 2 PATAS F204-2-90



Linea: H002
Clave: AR-0002 P
Acabados: SATIN Material: ACERO INOXIDABLE 304

ARAÑA CON PORTACOSTILLA DE 2 PATAS



Linea: H002
Clave: AR-0003
Acabados: SATIN Material: ACERO INOXIDABLE 304 F204-3

ARAÑA INSTALACION A VIGA 3 PATAS



Linea: H002
Clave: AR-0004
Acabados: SATIN Material: ACERO INOXIDABLE 304 F204-4

ARAÑA INSTALACION A VIGA 4 PATAS



Linea: H002
Clave: AR-0004 P
Acabados: SATIN Material: ACERO INOXIDABLE 304

ARAÑA CON PORTACOSTILLA DE 4 PATAS

Arañas y Rótulas

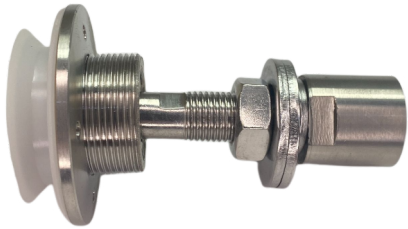

Linea: H003
Clave: RO-0001 A
Acabados: SATIN Material: ACERO INOXIDABLE 304

ROTULA AVELLANADA PARA ARAÑA SF-PZ

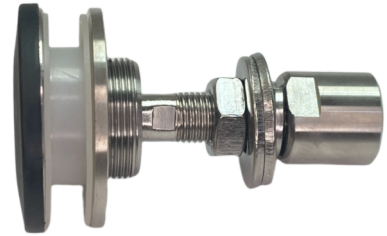

Linea: H003
Clave: RO-0001 E
Acabados: SATIN Material: ACERO INOXIDABLE 304

ROTULA ESTANDAR PARA ARAÑA SF-PT.



Linea: H003
Clave: RO-0001 R
Acabados: SATIN Material: ACERO INOXIDABLE 304

SOPORTE CON ROTULA T32



Linea: H003
Clave: SO-1000
Acabados: SATIN Material: ACERO INOXIDABLE 304

SOPORTE PARA INSTALACION A VIGA A01-M18

Bisagras Hidráulicas Y Kits Para Cristal

Bisagras Hidráulicas



DORTEC

Linea: H033
Clave: BH-1200 D

BISAGRA HIDRAULICA DORTEC DT-2300 PARA 130 KGS



DORMA

Linea: H033
Clave: BH-1200 DM1

BISAGRA HIDRAULICA DORMA BTS75-R PARA 180KGS



jackson

Linea: H033
Clave: BH-1200 J

BISAGRA HIDRAULICA JACKSON MOD 20-330

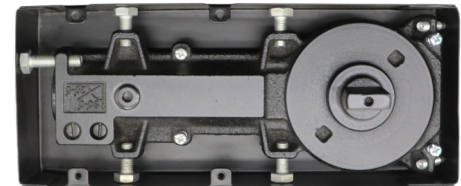

MAPLE

Linea: H033
Clave: BH-1200 B

BISAGRA HIDRAULICA MAPLE PARA 90 KGS

Kits Para Cristal

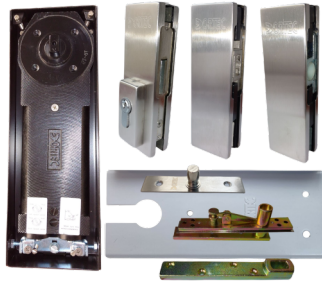

DORTEC

Linea: H034
Clave: BD-1201 S
Acabados: SATIN

KIT DE BISAGRA DORTEC DT-2300 CON HERRAJES PARA CRISTAL TEMPLADO



DORMA

Linea: H046
Clave: BD-1200 N
Acabados: SATIN

KIT BISAGRA HIDRAULICA DORMA BTS-75 R CON HERRAJES PARA CRISTAL TEMPLADO



MAPLE

Linea: H032
Clave: BB-1201 S
Acabados: SATIN

KIT DE BISAGRA MAPLE CON HERRAJES PARA CRISTAL TEMPLADO TAMBIÉN DISPONIBLES LOS HERRAJES POR SEPARADO



Linea: H030
Clave: KM-1200 S
Acabados: SATIN Material: ACERO INOXIDABLE

KIT MANET PARA PUERTA DE CRISTAL TEMPLADO

Kits Para Cristal



Linea: H048
Clave: MC-0000
Acabados: SATIN Material: ACERO INOXIDABLE

KIT PARA MARQUESINA DE CRISTAL 9CE



Linea: H034
Clave: HD-1613 AFS
Acabados: SATIN

HERRAJE PUNTO DE GIRO - LATERAL Y ANTEPECHO
DORTEC DT-7014 P



Linea: H034
Clave: HD-1613 AS
Acabados: SATIN

HERRAJE PUNTO DE GIRO Y ANTEPECHO DORTEC DT-7013



Linea: H034
Clave: HD-1613 CS
Acabados: SATIN
CERRADURA DORTEC DT-7010 ACERON INOXIDABLE SATINADO



Linea: H034
Clave: HD-1613 IS
Acabados: SATIN Material: ACERO INOXIDABLE

HERRAJE INFERIOR DORTEC DT-7011



Linea: H034
Clave: HD-1613 SS
Acabados: SATIN Material: ACERO INOXIDABLE

HERRAJE SUPERIOR DORTEC DT-7012



Linea: H034
Clave: HD-1613 PGS
Acabados: SATIN Material: ACERO INOXIDABLE

PUNTO DE GIRO DORTEC 721

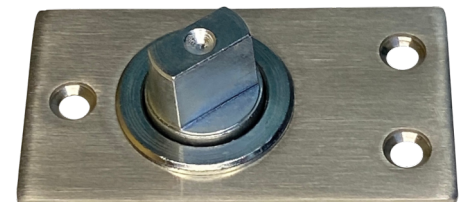

Linea: H030
Clave: HM-1613 PR
Acabados: SATIN Material: ACERO INOXIDABLE

PIVOTE DE ROLAMIENTO MANET

Kits Para Cristal



Linea: H045
Clave: BH-1300 PS
Acabados: SATIN

BISAGRA SIN PERFORACION AL PISO 100 KILOS



Linea: H045
Clave: HD-1614 SS
Acabados: SATIN

HERRAJE SUPERIOR 9CE PBISAGRA DE PISO SPERFORACION

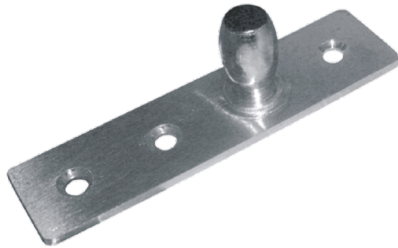

Linea: H045
Clave: HD-1614 PGS
Acabados: SATIN

HERRAJE PUNTO DE GIRO 9CE
PARA PIVOTE SUPERIOR HD-1614 SS

Bisagras para Cristal



Linea: H018
Clave: BC-1111 N
Acabados: NEGRO Material: ZAMAC

BISAGRA CRISTAL CRISTAL 9CE DE 8 A 12 MM



Linea: H018
Clave: BM-1113 N
Acabados: NEGRO Material: ZAMAC

BISAGRA MURO CRISTAL 9CE 8 A 12 MM



Linea: H019
Clave: BC-1111 S
Acabados: SATIN Material: ZAMAC

BISAGRA CRISTAL CRISTAL 9CE DE 8 A 12 MM



Linea: H019
Clave: BM-1113 S
Acabados: SATIN Material: ZAMAC

BISAGRA MURO CRISTAL 9CE 8 A 12 MM



Linea: H019
Clave: BM-1113 SD
Acabados: SATIN Material: ZAMAC

BISAGRA MURO CRISTAL DESFASADA 9CE 8 A 12 MM



Linea: H025
Clave: BM-1113 IS

BISAGRA IMPORTADA PARA MURO Y CRISTAL TEMPLADO 9 MMS

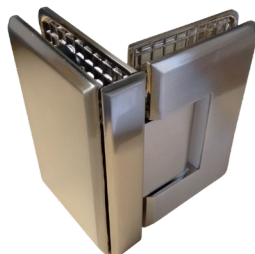

Linea: H026
Clave: BC-1111 190S

BISAGRA IMPORTADA PARA CRISTAL Y CRISTAL 90°
TEMPLADO 9 MMS



Linea: H026
Clave: BC-1111 IS

BISAGRA IMPORTADA PARA CRISTAL Y CRISTAL 180°
TEMPLADO 9 MM

Bisagras para Cristal

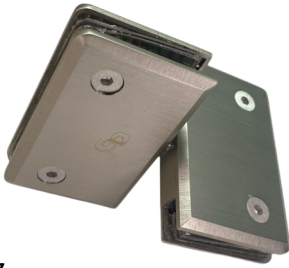

Linea: H027
Clave: BP-1113 360S
Acabados: SATIN

BISAGRA PIVOTANTE CRISTAL-CRISTAL 360°



Linea: H027
Clave: BP-1113 S
Acabados: CROMO Y SATIN

BISAGRA PIVOTANTE IMPORTADA



Linea: H073
Clave: BD-6001 S
Acabados: SATIN Y NEGRO

BISAGRA BIBEL DOBLE PARA VITRINA



Linea: H073
Clave: BS-5001 S
Acabados: SATIN Y NEGRO

BISAGRA BIBEL SENCILLO PARA VITRINA

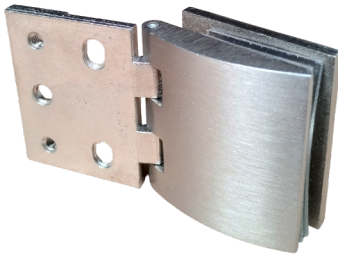

Linea: H246
Clave: BV-7001 S

BISAGRA PARA PUERTA BATIENTE DE VITRINA

Clipos para repisas de cristal



Linea: H302
Clave: CL-0000 BL
Acabados: COLORES BLANCO NEGRO CROMO SATIN

CLIPO BLANCO PARA VIDRIO 6 A 22 MM DE ESPESOR

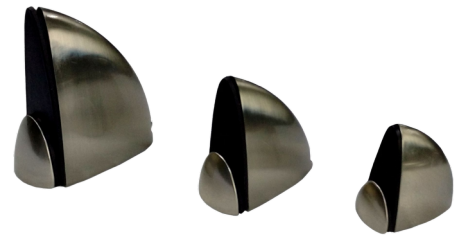

Linea: H306
Clave: CL-0002 CH, M, G
Acabados: SATIN Material: ZAMAC

CLIPO 9CE PARA VIDRIO DE 6 A 12 MM TAMAÑOS CHICO MEDIANO GRANDE



Linea: H306
Clave: CL-0003 SA
Acabados: SATIN

CLIPO GRANDE 75 MM NACIONAL PARA VIDRIO 6 A 22 MM



Linea: H337
Clave: CO-1810 S

CONECTOR CURVO PARA FIJOS DE VIDRIO 6-9 MM



Linea: H337
Clave: CO-1809 D, S

CONECTOR RECTO PARA FIJOS DE 8 A 10 MM DOBLE SENCILLO

Conectores y Clips para Cristal



Linea: H020
Clave: BF-1112 L, N
Acabados: SATIN, NEGRO Material: ZAMAC

CLIP DE FIJACION RECTO DE 90° 9CE BASE LATERAL



Linea: H020
Clave: BF-1112 S, N
Acabados: SATIN, NEGRO Material: ZAMAC

CLIP DE FIJACION 9CE DE 8 A 10 MM



Linea: H337
Clave: CO-1811 S, CO-1811 N180
Acabados: SATIN, NEGRO

CONECTOR RECTO VIDRIO-VIDRIO 180°

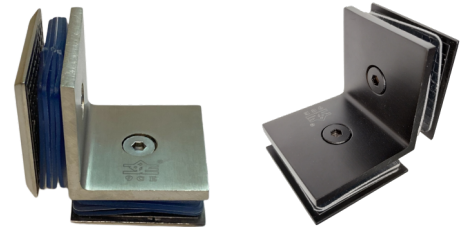

Linea: H337
Clave: CO-1811 S90
Acabados: SATIN, NEGRO

CONECTOR VIDRIO-VIDRIO 90°



Linea: H036
Clave: BF-1112 CS
Acabados: SATIN Y CROMO

CLIP DE FIJACION SIN RESAQUE BASE CURVA



Linea: H036
Clave: BF-1112 SC
Acabados: CROMADO Y SATIN

CLIP DE FIJACION SIN RESAQUE



Linea: H036
Clave: BF-1112 IS
Acabados: CROMO Y SATIN

CLIP DE FIJACION IMPORTADO



Linea: H337
Clave: CO-1809 D S
Acabados: SATIN

CONECTOR RECTO PARA FIJOS DE 8 A 10 MM DOBLE Y SENCILLO

Conectores y Clips para Cristal

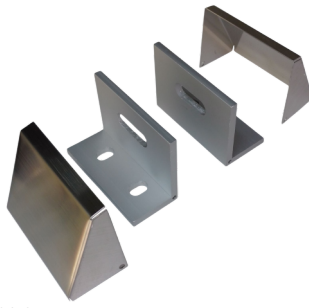

Linea: H337
Clave: CO-1820 S
Acabados: SATIN

CONECTOR ANGULO TITAN

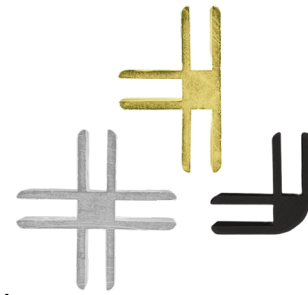

Linea: H334
Clave: CO-1804
Acabados: NATURAL DURANODIC ORO

CONECTOR PARA CRISTAL DE 3 A 6 MM TIPO "X" "T" "L"



Linea: H015
Clave: BE-1100 C Y BE-1100 M
Acabados: SATIN

BARRA ESTABILIZADORA AC. INOX CRISTAL CRISTAL Y MURO
CRISTAL DE 1.20 MTS

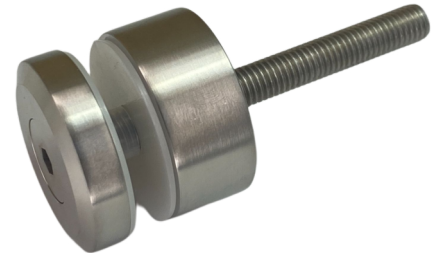

Linea: H028
Clave: CO-1814 S2
Acabados: SATIN

CONECTOR PARA BARANDAL VIDRIO MURO 45MM

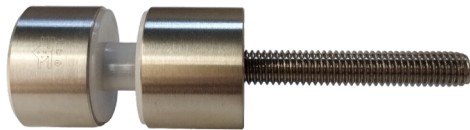

Linea: H028
Clave: CO-1915 S
Acabados: SATIN Y NEGRO

CONECTOR PARA BARANDAL 9CE CON TENSOR ADAPTABLE



Linea: H336
Clave: CO-1814 S
Acabados: SATIN

CONECTOR VIDRIO MURO 45MM

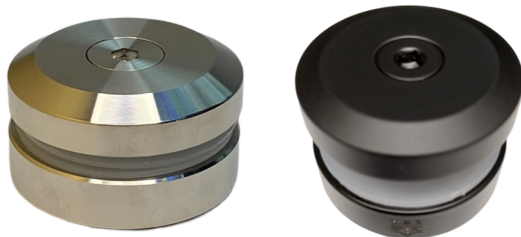

Linea: H337
Clave: CO-1811 E, N
Acabados: SATIN Y NEGRO

CONECTOR ESTABILIZADOR VIDRIO VIDRIO 45 MM 9CE



Linea: H326
Clave: CO-1802 NI
Acabados: CROMO

CONECTOR IMPORTADO PARA JALADERA DE CRISTAL TEMPLADO

Conectores y Clips para Cristal

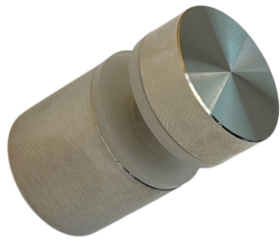

Linea: H336
Clave: CO-1812 S
Acabados: SATIN

CONECTOR VIDRIO MURO 19 X 16 MM CHICO



Linea: H336
Clave: CO-1812 SG
Acabados: SATIN

CONECTOR VIDRIO MURO 19 X 60 MM GRANDE



Linea: H336
Clave: CO-1812 SM
Acabados: SATIN

CONECTOR VIDRIO MURO 19 X 38 MM MEDIANO



Linea: H336
Clave: CO-1813 S
Acabados: SATINADO

CONECTOR DE FIJACION 32 X 50 VIDRIO MURO



Linea: H336
Clave: CO-1813 SM
Acabados: SATINADO

CONECTOR DE FIJACION 32 X 25 VIDRIO MURO MEDIANO



Linea: H337
Clave: CO-1819 S
Acabados: SATIN Material: ACERO INOXIDABLE

CONECTOR MURO A VIDRIO 8-10 MM



Linea: H337
Clave: CO-1818 S
Acabados: SATIN Material: ACERO INOXIDABLE

CONECTOR PIPETA PARA VIDRIO 8-10 MM

Conectores y Clips para Cristal



Linea: H335
Clave: CO-1818 CS
Acabados: SATIN Material: ACERO INOXIDABLE

CONECTOR PIPETA 9CE PARA VIDRIO 8-10 MM CON CHAPETON



Linea: H337
Clave: CO-1818 CN
Acabados: NEGRO Material: ACERO INOXIDABLE

CONECTOR PIPETA 9CE PARA VIDRIO 8-10 MM



Linea: H335
Clave: CO-1819 IS
Acabados: SATIN Material: ACERO INOXIDABLE 304

CONECTOR PIPETA DOBLE MAPLE

Herrajes Maple

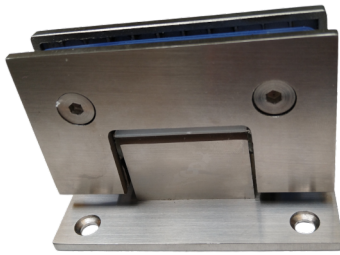

Linea: H025
Clave: BM-1113 IS
Acabados: SATIN Material: ACERO INOXIDABLE 304

BISAGRA IMPORTADA MURO CRISTAL MAPLE 9-12MM

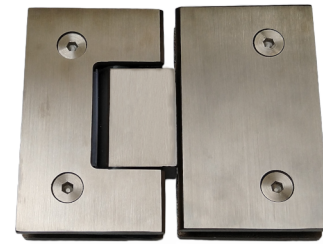

Linea: H026
Clave: BC-1111 IS
Acabados: SATIN Material: ACERO INOXIDABLE 304

BISAGRA IMPORTADA CRISTAL CRISTAL 180° MAPLE 9-12MM



Linea: H029
Clave: BF-1115 C
Acabados: CROMO Material: ACERO INOXIDABLE 304

CLIP DE FIJ BASE PLANA MAPLE PARA CRISTAL 9-12M



Linea: H029
Clave: BF-1115 IS
Acabados: SATIN Material: ACERO INOXIDABLE 304

CLIP DE FIJACION MAPLE PARA CRISTAL TEMPLADO 9-12 MM



Linea: H029
Clave: BF-1115 L
Acabados: SATIN Material: ACERO INOXIDABLE 304

CLIP DE FIJACION DE 90 BASE LATERAL MAPLE 9-12 M



Linea: H029
Clave: BF-1115 SP
Acabados: SATIN Material: ACERO INOXIDABLE 304

CLIP DE FIJACION BASE PLANA MAPLE PARA CRISTAL 9-12 M



Linea: H335
Clave: CO-1815 S
Acabados: SATIN Material: ACERO INOXIDABLE 304

CONECTOR RECTO VIDRIO-VIDRIO 180 MAPLE 9-12MM

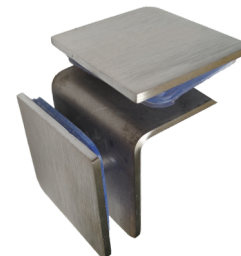

Linea: H335
Clave: CO-1815 S90
Acabados: SATIN Material: ACERO INOXIDABLE 304

CONECTOR VIDRIO-VIDRIO 90 MAPLE 9-12MM

Jaladeras para Cristal Templado



Linea: H018
Clave: CO-1803 BN
Acabados: NEGRO

CONECTOR IMPORTADO DE BOLA PARA BAÑO 9CE



Linea: H018
Clave: CO-1803 N, S,
Acabados: NEGRO, SATIN

CONECTOR IMPORTADO DE PELLIZCO 9CE

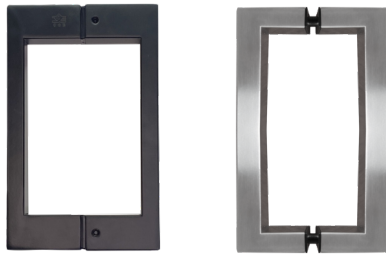

Linea: H018
Clave: JA-2227 CN, JA-2227 CS
Acabados: NEGRO Y SATIN

JALADERA IMPORTADA 9CE TIPO C DE 6" PCRISTAL



Linea: H041
Clave: JA-2227 EC
Acabados: NEGRO SATIN Y CROMO

JALADERA TOALLERO 45 x 20 x 1" 9CE



Linea: H018
Clave: JA-2227 IN
Acabados: NEGRO, SATIN Y CROMO

JALADERA IMPORTADA 9CE TIPO C DE 6" PARA CRISTAL



Linea: H018
Clave: PT-0000 N
Acabados: NEGRO

PORTA TOALLA 9CE



Linea: H018
Clave: TO-0000 N
Acabados: NEGRO

TOALLERO 9CE

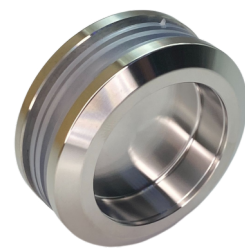

Linea: H021
Clave: JA-2225 S
Acabados: SATIN

JALADERA 9CE PARA CANCEL DE BAÑO DE 8 A 12 MM CB-1204

Jaladeras para Cristal Templado



Linea: H037
Clave: JA-2218 IN
Acabados: NEGRO, SATIN Y CROMO

JALADERA H DE 40CM X 30CM ENTRE CENTROS DE 1" 9CE



Linea: H037
Clave: JA-2219 RC
Acabados: NEGRO, SATIN Y CROMO

JALADERA H DE 1.00MT X 60 ENTRE CENTROS RECTA 9CE

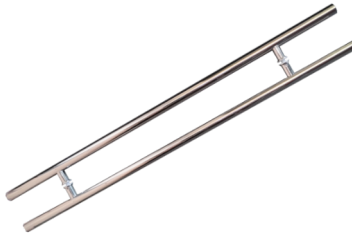

Linea: H037
Clave: JA-2221 RC
Acabados: NEGRO, SATIN Y CROMO Material: ACERO INOXIDABLE

JALADERA H DE 1.20MT X 80 ENTRE CENTROS RECTA 9CE

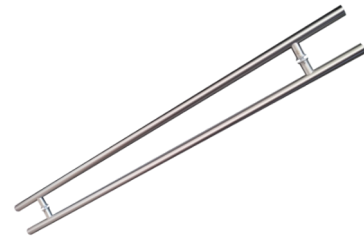

Linea: H037
Clave: JA-2222 RS
Acabados: NEGRO, SATIN Y CROMO Material: ACERO INOXIDABLE

JALADERA H DE 1.50MT X 1.20 ENTRE CENTROS RECTA 9CE



Linea: H037
Clave: JA-2223 S
Acabados: NEGRO, SATIN Y CROMO

JALADERA TIPO H CON CHAPA
DE 1.50 MT, ENTRE CENTROS DE 1.125MT 35MM 9CE



Linea: H040
Clave: JA-2229 C
Acabados: SATIN

JALADERA CIRCULAR 9CE DE 30 CMS



Linea: H040
Clave: JA-2229 CS
Acabados: SATINADA Y CROMO

JALADERA CURVA 9CE ENTRE CENTROS 30CMS



Linea: H040
Clave: JA-2229 RS
Acabados: SATINADA Y CROMO

JALADERA RECTA 9CE ENTRE CENTROS 30CMS

Jaladeras para Cristal Templado



Linea: H040
Clave: JA-2229 SS
Acabados: SATINADA

JALADERA SEMIRECTA 9CE ENTRE CENTROS 30CMS



Linea: H042
Clave: JA-2217

JALADERA DE LUJO PARA PUERTA DE CRISTAL



Linea: H044
Clave: JA-2228 S
Acabados: SATIN Material: ACERO INOXIDABLE

JALADERA TIPO OXO DE 33.7 X 30.5 ENTRE CENTROS 9CE



Linea: H326
Clave: CO-1802 AI
Acabados: SATIN Material: ACERO INOXIDABLE

CONECTOR PARA JALADERA DE CRISTAL 9CE



Linea: H328
Clave: CO-1803 LS
Acabados: SATIN Material: ACERO INOXIDABLE

CONECTOR PARA BAÑO IMPORTADO LISO 9CE

Herrajes para líneas europeas

Linea 1400/2500



Linea: H051
Clave: BE-1400 2BL
Acabados: BLANCO NEGRO PLATA

BISAGRA EUROPEA DE 2 PALAS INVERTIBLE PARA SERIE 1400
TAMBIEN DISPONIBLE PARA SERIE 6000



Linea: H051
Clave: BE-1400 3D
Acabados: NEGRO BLANCO PLATA

BISAGRA EUROPEA DE 3 PALAS INVERTIBLE SERIES 1400
TAMBIEN DISPONIBLE PARA SERIE 6000



Linea: H062
Clave: CK-1400 N
Acabados: NEGRO, BLANCO, PLATA

CREMONA ESPAÑOLA PARA SERIE 1400



Linea: H062
Clave: KC-1400

KIT DE HERRAJES PARA CREMONA SERIE 1400



Linea: H372
Clave: EP-1400

ESCUADRA PARA PUERTA SERIE 1400

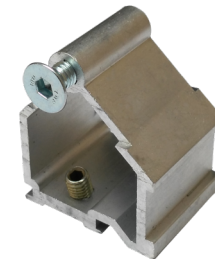

Linea: H372
Clave: EU-1400 P

ESCUADRA UNION PILASTRA PUERTA 1400

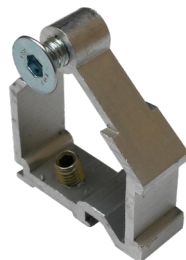

Linea: H372
Clave: EU-1400 V

ESCUADRA UNION PILASTRA VENTANA 1400

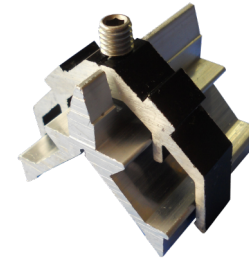

Linea: H372
Clave: EV-1400

ESCUADRA PARA VENTANA SERIE 1400

Herrajes para líneas europeas

Linea 1400/2500



Linea: H608
Clave: PA-1400 BL,N
Acabados: BLANCO NEGRO

PASADOR PLANO BAM SERIE 1400

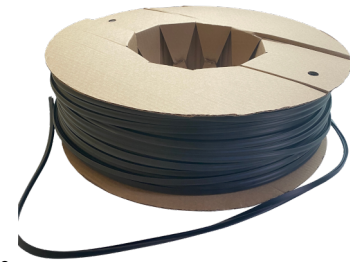

Linea: H819
Clave: VI-1400 N
Acabados: NEGRO

VINIL BASE RIGIDA MAPLE PARA SERIE 1400 ROLLO 200 MT



Linea: H819
Clave: VI-1400 R
Acabados: NEGRO

VINIL GOMA RESPALDO MAPLE ROLLO 200 MT

Linea 3500



Linea: H062
Clave: KJ-3500

KIT DE EMPAQUES PARA SERIE 3500



Linea: H164
Clave: CA-3500 S

CARRETILLA PARA SERIE 3500 SENCILLA

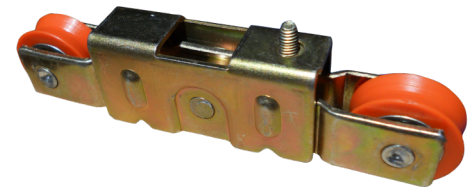

Linea: H164
Clave: CA-3500 T

CARRETILLA PARA SERIE 3500 TANDEM

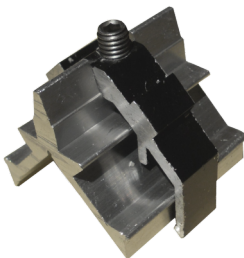

Linea: H372
Clave: ES-3500

ESCUADRA PARA SERIE 3500

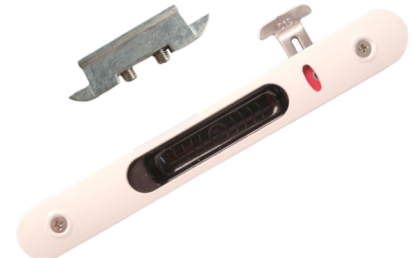

Linea: H476
Clave: JA-3500 BL
Acabados: BLANCA, NEGRO, PLATA

JALADERA DE EMBUTIR SERIE 3500

Herrajes para líneas europeas

Línea 4600/4000



Linea: H061
Clave: MA-2309 NG
Acabados: NEGRA, BLANCA, PLATA

MANILLA RECTA ESPAÑOLA BAM PARA MULTIPUNTO



Linea: H061
Clave: MA-2311 BL
Acabados: BLANCA Y NEGRA

MANILLA PARA MULTIPUNTO CON LLAVE



Linea: H061
Clave: MP-6000

KIT DE MULTIPUNTO 600 MM 1000 MM 1400 MM
CON ACCESORIOS PARA INSTALACION MARCA BAM



Linea: H065
Clave: KJ-4600

KIT DE ACCESORIOS PARA SERIE 4600



Linea: H165
Clave: CA-4600 S

CARRETILLA REGULABLE BAM PARA LINEA 4600



Linea: H165
Clave: CA-4600 T

CARRETILLA TANDEM BAM SERIE 4600



Linea: H165
Clave: CA-4600 SP

CARRETILLA REGULABLE DE PLASTICO SERIE 4600



Linea: H165
Clave: CA-4600 TP

CARRETILLA TANDEM DE PLASTICO SERIE 4600

Herrajes para líneas europeas

línea 4600/4000

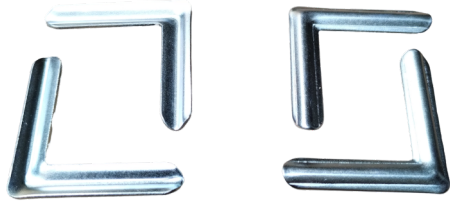

Linea: H373
Clave: ES-4600 A

ESCUADRA DE ALINEACION PARA SERIE 4600

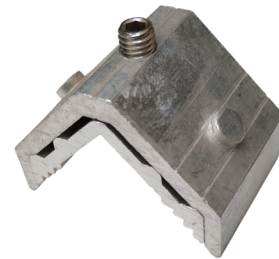

Linea: H373
Clave: ES-4600 CF

ESCUADRA ESPAÑOLA CERCO Y FIJO SERIE 4600



Linea: H373
Clave: ES-4600 CT

ESCUADRA ESPAÑOLA CERCO TRES RIELES SERIE 4600

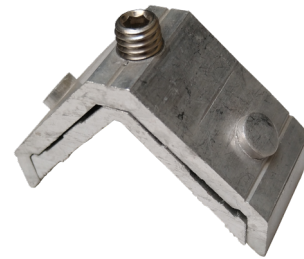

Linea: H373
Clave: ES-4600 H

ESCUADRA ESPAÑOLA HOJA SERIE 4600



Linea: H384
Clave: FE-4600 N
Acabados: GRIS, NEGRO

FELPA LINEA 4600 IMPORTADA POR ROLLO 350 MTS



Linea: H477
Clave: JA-4600 N
Acabados: NEGRA, BLANCO, PLATA

JALADERA DE EMBUTIR BAM SERIE 4600 CON TORNILLO F-303

Herrajes para líneas europeas

línea 4600/4000



Linea: H477
Clave: JA-4600 SPL
Acabados: BLANCO, NEGRO, PLATA

JALADERA DE EMBUTIR BAM SERIE 4600 SIN TORNILLO F-310



Linea: H560
Clave: MG-4600 BL
Acabados: BLANCO, NEGRO, PLATA

MANGO ADAPTAPTABLE BAM SERIE 4600



Linea: H609
Clave: PA-4600 BL
Acabados: BLANCO, NEGRO, PLATA, CHAMPAGNE

PASADOR PLANO BAM SERIE 4600

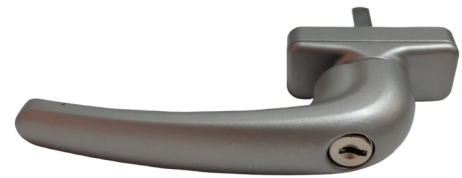

Clave: MA-2310 PL
Acabados: BLANCO, NEGRO, Y PLATA

MANILLA CON LLAVE ITALIANA PARA MULTIPUNTO



Tabla De Productos Para Líneas Españolas

Foto	Marca	Línea Clave ComDublin	Cuprum			Extrusiones Metálicas				Indalium							
			Serie 35 S-45	Serie 80 S-AB-P.YS-AB-V	S-150	S-50 PyV	S-100, 100 AR y 70	L-4600	L-1400 V	L-1400 P	L-6000	L-3500	L-4000	2500B	S-4500	S-3800 YS-3900	B-3500
	ComDublin	EU-1400 V										★					
	ComDublin	EV-1400										★					
	ComDublin	EJ-1400									★						
	ComDublin	ES-4600 CF								★							
	ComDublin	ES-4600 CT								★							
	ComDublin	ES-4600 H								★							
	Monticelli/Master (Italiana)	ES-0417	★							★							
	Monticelli/Master (Italiana)	ES-0421	★		★					★							★
	BAM (Español)	JA-3500 (Incluye contra y gancho)														★	
	BAM (Español)	JA-4600 (Incluye contra y gancho)								★							
	BAM (Español)	JA-4600 S Sin Tornillo (Incluye contra y gancho)								★							
	BAM (Español)	KJ-4600								★							
	BAM (Español)	KJ-3500														★	
	BAM (Español)	VI-1400															★
	BAM (Español)	FE-4600															★
	DGS (Inglés)	BR-1400															★
	BAM (Español)	PA-4600															★
	BAM (Español)	PA-1400 (Reforzado)															★
	BAM (Español)	MP-6000 multipunto															★
	BAM (Español)	MA-2309 NG (manilla para multipunto)															★
	BAM (Español)	BR-1400 A															★

Herramienta

Brocas

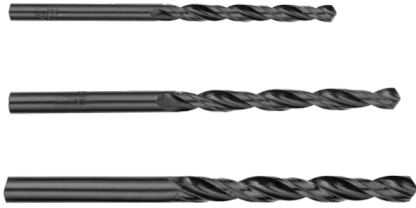

Linea: H094
Clave: BR-1302 F

BROCA DE ALTA VELOCIDAD DE VARIAS MEDIDAS



Linea: H095
Clave: BR-1306 C

BROCA PARA CONCRETO DE 1/4 X 4" Y 1/4X6"



Linea: H096
Clave: BR-1308 A

BROCA AVELLANADORA MEDIDA 3/8



Linea: H096
Clave: BR-1308 A

BROCA AVELLANADORA MEDIDA 1/2



Linea: H096
Clave: BR-1310 A

AVELLANADOR DE CARBURO DE TUGSTENO 82°



Linea: H096
Clave: BR-1310 V

BROCA PARA VIDRIO PUNTA DE LANZA 3/8 10mm

Cargadores para Vidrio



Linea: H809
Clave: VE-0001 I

CARGADOR PARA VIDRIO IMPORTADO METALICO
1 VENTOSA 45 KGS



Linea: H809
Clave: VE-0002 I

CARGADOR PARA VIDRIO IMPORTADO METALICO 2 VENTOSAS



Linea: H809
Clave: VE-0003 I

CARGADOR PARA VIDRIO IMPORTADO METALICO 3 VENTOSAS

Cortavidrio y Disco



Linea: H354
Clave: CV-1900

CORTAVIDRIO SILBERSCHNITT ALEMAN DE 6 DISCOS



Linea: H354
Clave: CV-1901

CORTAVIDRIO DIAMANTOR



Linea: H354
Clave: CV-1903

CORTAVIDRIO FLETCHER



Linea: H354
Clave: CV-1905

CORTAVIDRIO TOYO CON DEPOSITO PARA LUBRICANTE



Linea: H354
Clave: CV-1905 C

CABEZAL ANCHO PARA CORTAVIDRIO TOYO (CG)



Linea: H354
Clave: CV-1905 I

CORTAVIDRIO TIPO TOYO CON DEPOSITO PARA LUBRICANTE



Linea: H358
Clave: CV-1902
Material: LATON

CORTACIRCULOS VARIOS DIAMETROS
0.60 MTS 1.20M 1.60M 2.00M



Linea: H362
Clave: DC-0000

DISCO PARA CORTE DE 10 100 DIENTES

Herramienta



Linea: H386
Clave: FM-2300

FLEXOMETRO PRETUL DE 3 Y 5 MTS



Linea: H024
Clave: ESPATULA C

ESPATULA ESQUINA REDONDA Y COSTILLA



Linea: H394
Clave: GA-1510

GARRUCHA PARA FIJAR VINIL 2126



Linea: H394
Clave: GA-1512

GUANTES CON LATEX

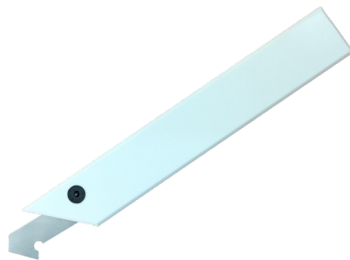

Linea: H394
Clave: GA-1513 O

GARFIO PARA CORTAR ACRILICO CON NAVAJA OLFA



Linea: H394
Clave: GA-1513

GARFIO PARA CORTAR ACRILICO CON NAVAJA CAMBIABLE



Linea: H394
Clave: GA-1513 RO

REPUESTO DE NAVAJA PARA GARFIO OLFA 3 PZAS



Linea: H394
Clave: GA-1513 R

REPUESTO DE NAVAJA PARA GARFIO CORTA ACRILICO 5 PZAS

Herramienta



Linea: H574
Clave: NA-0000

NAVAJA (CUTTER) TRUPER ALMA DE METAL



Linea: H514
Clave: LI-0000

LIJA DE BANDA VARIAS MEDIDAS

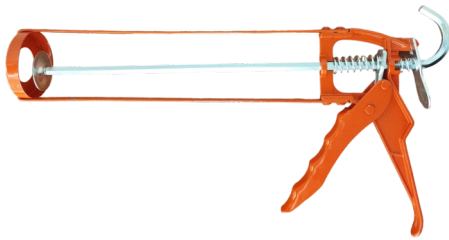

Linea: H650
Clave: PS-2800 AM

PISTOLA DE CALAFATEO TIPO ALEMAN METALICA



Linea: H710
Clave: SE-3405

SEGUETA DE DIENTE FINO Y GRUESO

Herramienta

Linea MPT



Linea: H387
Clave: DS-4010

JUEGO DE DESARMADORES MPT 4 PZAS CON PUNTA MAGNÉTICA



Linea: H387
Clave: LA-7010

JUEGO DE LLAVES ALLEN MPT 7 PZAS CON MANGO ERGONOMICO



Linea: H387
Clave: MP-1601

MARTILLO PROFESIONAL MPT DE 16 OZ

MPT

MOST PROFESSIONAL TOOLS



Linea: H387
Clave: TI-6021

TALADRO INALAMBRICO DE IMPACTO SIN ESCOBILLAS MPT USO PROFESIONAL

TALADRO PROFESIONAL MPT

Taladro inalámbrico de impacto sin escobillas MPT uso profesional

Especificación técnica

- Voltaje: 21V
- Tamaño de mandril: 13 mm(1/2")
mandril de metal
- Velocidad sin carga: 0-40070 - 2200 rpm
- Tasa de impacto: 0-5700/0-31000 bpm
- Ajuste de torque: 20 + 3
- Torque max: 60 Nm
- Motor: Sin escobillas

Incluye: 2 baterías, cargador, maleta,
2 puntas cruz/plana

Troqueles

Para Línea 1400 y 2500



Línea: H387
Clave: PZ-1400

PRENSA MANUAL PUNZADORA ESPAÑOLA AZ
PARA LÍNEAS 1400-2500

El troquel **AZ INTIMAT** de fabricación española para la línea 1400 (EXTRUSIONES) y 2500 (INDALUM) sirve para hacer perforaciones y cortes precisos en perfiles de aluminio para la fabricación de ventanas y cancelas.

Características:

- Cuenta con tope de posición que nos permite centrar los perfiles para un corte preciso.
- Fácil recorrido de palanca gracias a su engranaje mecánico.
- Cuchillas y ranuras en acero templado de alta dureza.

Compatibilidad:

ESPAÑOLA INDALUM
S-1400 S-2500

Nuestros Herrajes Recomendados:

EP-1400, EV-1400

Medidas generales:

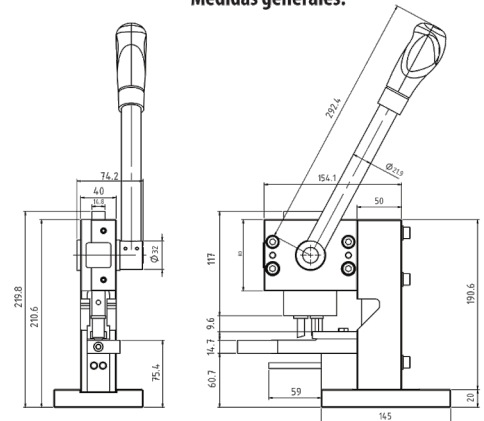

Para Línea 4600/4000



Línea: H387
Clave: PZ-4600

TROQUEL MULTIPLE ESPAÑOL AZ PARA LINEA 4600

La prensa troqueladora **AZ INTIMAT** de fabricación Española CP-4600/EM-4 de construcción robusta y duradera, está diseñada para trabajar con perfiles de aluminio de la Serie 4600, usados en ventanas y puertas correderas, es de uso manual, lo que permite cortes y troquelados precisos en marcos, hojas y tapas.

Compatibilidad:

Perfiles Serie 4600 (4605, 4606, 4651, 4652, 4654). Perfiles serie 4000 (INDALUM)

Nuestros Herrajes Recomendados: KJ-4600, ES-4600 A, ES-4600 CF, ES-4600 CT ES-4600 H, JA-4600 BL, JA-4600 SBL

Aplicaciones:

sirve para realizar cortes y perforaciones de forma precisa y repetitiva en los perfiles de la serie. Esto garantiza la correcta unión de las piezas y un acabado profesional en el producto final fabricación de componentes, drenajes y tapas.

Ventajas:

Las ventajas del troquel para la serie de perfiles 4600 radican en su precisión y eficiencia para la fabricación de ventanas y puertas correderas de aluminio.

Precisión en cortes y troquelados.

Versátil para distintos perfiles de la serie.

Larga vida útil con mantenimiento adecuado.

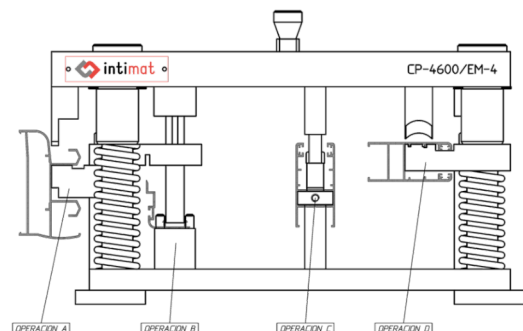

Película Decorativa



Linea: H024
Clave: PELCUADRO C

PELICULA DECORATIVA ESMERILADA CUADRO
35X35 MM 1.50 X 30 MTS

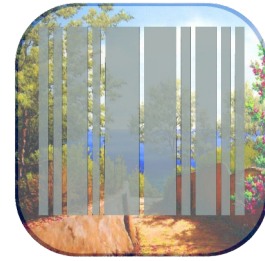

Linea: H024
Clave: PELLUVIA C

PELICULA ESMERILADA LLUVIA 1.50 X 30 MTS



Linea: H024
Clave: PELMATE C

PELICULA DECORATIVA MATE 1.50 X 30 MTS



Linea: H024
Clave: PELRAYA C

PELICULA ESMERILADA RAYAS 45MM DE 1.50 X 30 MTS



Linea: H024
Clave: PELREFLECTA 2

PELICULA GRIS PLATA CON CONTROL SOLAR 1.52 X 30 MTS



Linea: H024
Clave: PELSEGURIDAD C

PELICULA DE SEGURIDAD 1.50 X 30 MTS

Silicones, selladores, pegamentos

GNS



Linea: H367
Clave: EP-3300

ESPUMA EXPANSIVA UNIVERSAL DE POLIURETANO GNS A22



Linea: H720
Clave: SI-3390 BL
Acabados: BLANCO Y NEGRO

SELLADOR ACRILICO GNS S211



Linea: H771
Clave: SI-3380 T
Acabados: TRANSPARENTE, BLANCO Y NEGRO

SILICON MULTIUSO FUNGICIDA GNS G33



Linea: H772
Clave: SI-3370 NG
Acabados: NEGRO Y BLANCO

SELLADOR DE POLIURETANO GNS PU765

Silicones selladores pegamentos

Olive

Olive



Linea: H721
Clave: SI-3316 BL
Acabados: BLANCO NEGRO GRIS

SELLADOR ACRILICO D-70 OLIVE



Linea: H747
Clave: SI-3320 EN
Acabados: NEGRO

SILICON OLIVE SG-71 ESTRUCTURAL



Linea: H753
Clave: SI-3317 NT
Acabados: TRANSPARENTE

SILICON OLIVE 400 NEUTRA FACHADA DE VIDRIO



Linea: H755
Clave: SI-3317 PN
Acabados: NEGRO Y BLANCO

SELLADOR POLIURETANO OLIVE



Linea: H769
Clave: SI-3317 T
Acabados: TRANSPARENTE BLANCO NEGRO

SILICON OLIVE MULTIUSO ANTIHONGO

Silicones selladores pegamentos

Pennsylvania



Linea: H722
Clave: SI-3300 BL
Acabados: BLANCO NEGRO GRIS

ACRILASTIC PENNSYLVANIA



Linea: H723
Clave: SI-3300 BLP
Acabados: BLANCO NEGRO GRIS

ACRILASTIC PENNSYLVANIA PEPE



Linea: H750
Clave: SI-3309 T
Acabados: TRASPARENTE, BLANCO

SILICÓN BAÑOS Y COCINAS ANTI HONGOS



Linea: H750
Clave: SI-3319 N
Acabados: NEGRO

SILICON NEUTRO PCONSTRUCCION II PENNSYLVANIA



Linea: H752
Clave: SI-3308 T
Acabados: TRASPARENTE

SILICON PENNSYLVANIA POLICARBONATO



Linea: H754
Clave: SI-3311 N
Acabados: NEGRO BLANCO GRIS

SELLADOR DE POLIURETANO PARA JUNTAS CON MOVIMIENTO



Linea: H758
Clave: SI-3312 T
Acabados: TRASPARENTE NEGRO BLANCO

SILICÓN PENNSYLVANIA 100% USO GENERAL

Silicones selladores

Pennsylvania



Linea: H759
Clave: SI-3312 TP
Acabados: TRANSPARENTE NEGRO BLANCO

SILICON PENNSYLVANIA PEPE



Linea: H762
Clave: SI-3315 FT
Acabados: TRANSPARENTE

FERRESILICON PENNSYLVANIA



Linea: H765
Clave: SI-3322 AL
Acabados: ALUMINIO y NEGRO

SILICON PENNS ALUMIPANEL



Linea: H768
Clave: SI-3324 BL
Acabados: BLANCO

SILICON PENNSYLVANIA IND. HI TECH



Linea: H767
Clave: PG-1202 2

PEGAMENTO FIJASET II PENNSYLVANIA CARTUCHO 290ML



Linea: H764
Clave: SI-3312 HB
Acabados: BLANCO

SILICON PENNSYLVANIA HI BOND

Silicones selladores pegamentos

DOW / Sista



Linea: H730
Clave: SI-3301 T
Acabados: TRANSPARENTE

SELLADOR SILICON 1199 PARA POLICARBONATO



Linea: H734
Clave: SI-3302 T
Acabados: TRANSPARENTE BLANCO NEGRO

SILICON DOW CORNING 781



Linea: H738
Clave: SI-3303 T
Acabados: BLANCO Y NEGRO

SILICON SISTA GENERAL TRANSPARENTE



Linea: H770
Clave: SI-3318 T
Acabados: TRANSPARENTE Y NEGRO

SILICON SISTA MULTIUSOS



Linea:
Clave: SI-3306 T
Acabados: TRANSPARENTE Y BLANCO

SILICON PARA PLASTICOS, METALES Y MAMPOSTERIA

Silicones selladores pegamentos

Otras Marcas



Linea: H767
Clave: PG-1202 2

PEGAMENTO FIJASET II PENNSYLVANIA CARTUCHO 290ML



Linea: H764
Clave: SI-3312 HB
Acabados: BLANCO

SILICON PENNSYLVANIA HI BOND



Linea: H634
Clave: PG-1200 G

PEGAMENTO GUNTHER ULTRA



Linea: H634
Clave: PG-1200 L

PEGAMENTO LOCTITE 20 ML. Y ACELERADOR 170 GR



Linea: H746
Clave: SI-3307 BL
Acabados: BLANCO NEGRO GRIS

SILICON DOW CORNING 795

Sistemas corredizos y de apertura

Cancel para Baño



Linea: H015
Clave: SC-0001 M - SC-0001 C
Acabados: SATIN Material: ACERO INOXIDABLE 304

SISTEMA CORREDIZO DALLAS PARA PUERTAS, MARCA 9CE PARA MURO - CRISTAL, Y CRISTAL - CRISTAL

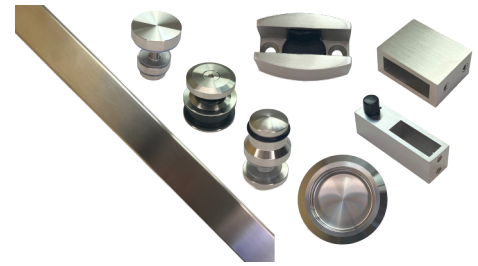

Linea: H016
Clave: CB-1202 S
Acabados: SATIN Material: ACERO INOXIDABLE 304

CANCEL DE BAÑO HOUSTON 2 MTS BORUI



Linea: H016
Clave: CO-1202 S
Acabados: SATIN, NEGRO

CONECTOR ESCUADRA PBARRA DE CANCEL HOUSTON



Linea: H017
Clave: CB-1200 NBI
Acabados: NATURAL BRILLANTE, NATURAL, NEGRO, BLANCO

CANCEL DE BAÑO SAO PAULO IMPORTADO EN TAMAÑOS DE 1.50 X 2.00 MTS Y 2.00 X 2.00 MTS



Linea: H021
Clave: CB-1204 C50

KIT CARRETILLAS PARA CANCEL DE BAÑO 50 KGS



Linea: H021
Clave: CB-1204 C70

KIT CARRETILLA PARA CANCEL DE BAÑO 70 KGS

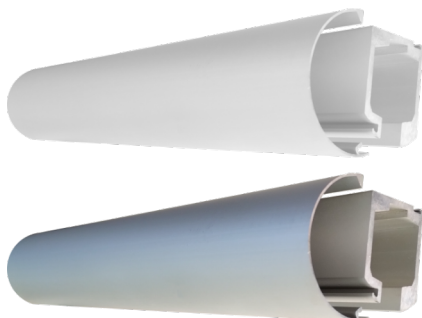

Linea: H021
Clave: CB-1204 RBL
Acabados: BLANCO Y NATURAL

RIEL PARA CANCEL DE BAÑO DE 2 METROS CON TAPA DE LUJO

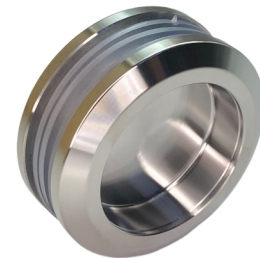

Linea: H021
Clave: JA-2225 S
Acabados: SATIN

JALADERA 9CE PARA CANCEL DE BAÑO DE 8 A 12 MM PARA CANCEL CB-1204

Sistemas corredizos y de apertura



Linea: H022
Clave: CB-1200 B
Acabados: BLANCO NEGRO NATURAL Y NATURAL BRILLANTE

CANCEL DE BAÑO SUJECION PHILLIPS
MEDIDAS DE 1.50 X 2.00 MTS. Y 2.00 MTS X 2.00 MTS

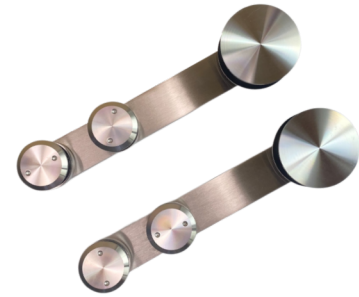

Linea: H047
Clave: SC-0000 C
Acabados: SATIN Material: ACERO INOXIDABLE

CARRETILLA PARA SISTEMA CORREDIZO



Linea: H047
Clave: SC-0000 CF
Acabados: SATIN Material: ACERO INOXIDABLE

CONECTOR FINAL PARA SISTEMA CORREDIZO

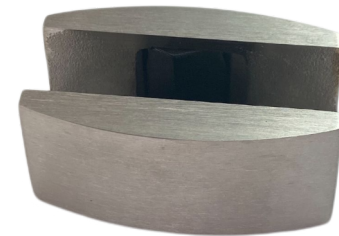

Linea: H047
Clave: SC-0000 G
Acabados: SATIN Material: ACERO INOXIDABLE

GUIA PARA SISTEMA CORREDIZO



Linea: H047
Clave: SC-0000 SC
Acabados: SATIN Material: ACERO INOXIDABLE

SOPORTE PARA SISTEMA CORREDIZO A CRISTAL

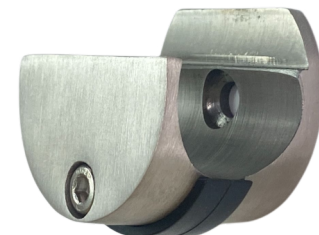

Linea: H047
Clave: SC-0000 SM
Acabados: SATIN Material: ACERO INOXIDABLE

SOPORTE PARA SISTEMA CORREDIZO A MURO

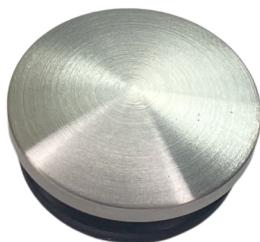

Linea: H047
Clave: SC-0000 TA
Acabados: SATIN Material: ACERO INOXIDABLE

TAPAS PARA TUBO 1 PULGADA DE SISTEMA CORREDIZO



Linea: H047
Clave: SC-0000 TO
Acabados: SATIN Material: ACERO INOXIDABLE

TOPE PARA SISTEMA CORREDIZO

SANBEN

MEJORAMOS EL SISTEMA SANBEN

- AHORA INCLUYE 2 CONTROLES REMOTOS PARA UN POSIBLE MANEJO A DISTANCIA
- MANUAL EN ESPAÑOL PARA FÁCIL INSTALACIÓN
- 4 CARRETILLAS AJUSTABLES REFORZADAS PARA 500 MIL CICLOS
- TAPA DE ALUMINIO ANODIZADO NATURAL DE 4.20 MTS

CARACTERÍSTICAS GENERALES:

- RIEL DE ALUMINIO ANODIZADO NATURAL DE 4.20 MTS
- 2 SENSORES; INTERIOR Y EXTERIOR
- UN MOTOR
- CORREA DE APERTURA Y CIERRE DE 8MTS
- SISTEMA SILENCIOSO RECOMENDADO PARA ÁREA COMERCIAL Y RESIDENCIAL
- OPERACIÓN MANUAL CON SWITCH DE APAGADO
- COMPUTADORA DE FÁCIL MANEJO Y CONFIGURACIÓN
- CAPACIDAD DE TRABAJO EN TEMPERATURAS DE -20C A +50C
- CAPACIDAD DE CARGA DE HASTA 150KGS



Linea: H031
Clave: SC-1000

SISTEMA SANBEN AUTOMATICO PARA PUERTAS CORREDIZAS



Linea: H031
Clave: SC-1000 B

BANDA DE RESPUESTO SISTEMA SANBEN



Linea: H031
Clave: SC-1000 S

SENSOR PARA SISTEMA SANBEN REPUESTO

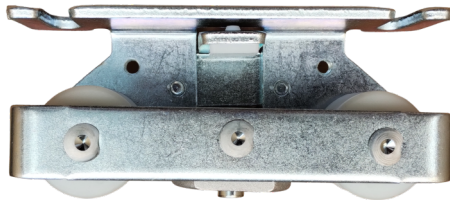

Linea: H031
Clave: SC-1001 RB

RODAJA PARA BANDA DE RESPUESTO SISTEMA SANBEN



Linea: H031
Clave: SC-1000 C

COMPUTADORA PARA SISTEMA SANBEN REPUESTO

Tornillería

Pijas



Linea: H638

Clave: PI-2703 N

Acabados: GALVANIZADA Y PAVONADA

PIJA CABEZA PLANA NATURAL VARIAS MEDIDAS
DESDE 8 Y 10 Y LARGOS DESDE 8 X 1/2" HASTA 10 X 2"



Linea: H642

Clave: PI-2712 F

Acabados: GALVANIZADA

PIJA DE CABEZA FIJADORA VARIAS MEDIDAS
DESDE 8 X 1/2" HASTA 10 X 2"



Linea: H646

Clave: PI-2700 AI

PIJA ACERO INOXIDABLE CABEZA PLANA



Linea: H647

Clave: PI-2710 FAI

PIJA DE CABEZA FIJADORA ACERO INOXIDABLE
VARIAS MEDIDAS 8 Y 10 Y LARGOS DESDE 8X1/2" HASTA 10X2"

Tensor

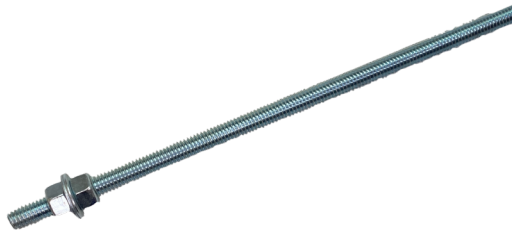

Linea: H798

Clave: TN-3900

Acabados: GALVANIZADO

TENSOR DE 3/8 X 1.00 MTS, 1.20M. Y 3.00 MTS
CON RONDANA Y TUERCA

Tornillos



Linea: H802

Clave: TO-4100 N

Acabados: GALVANIZADO Y PAVONADO

TORNILLO PARA MADERA MEDIDAS DE 8 Y 10 Y
LARGOS DESDE 8X1 1/2" HASTA 10X3"



Linea: H804

Clave: TO-4101 AI

TORNILLO PARA MADERA DE ACERO INOXIDABLE,
MEDIDAS 8 X 2" 8 X 2 1/2", 8 X 3" 10 X 2", 10 X 2/2", 10 X 3"

Varios, misceláneos



Linea: H000
Clave: AT-0000

AFLOJATODO LUBRICANTE WD-40 311 ML 11.02 OZ



Linea: H366
Clave: EP-0000

ESPUMA EXPANSIVA UNIVERSAL

Limpiadores



Linea: H512
Clave: CR-0001

CREMA QUITA GOTAS



Linea: H510
Clave: LA-2001

LIMPIADOR PARA ALUM. PULIMET 275 GRS



Linea: H510
Clave: LA-2002

LIMPIADOR PARA ALUMINIO PULIMET EN BARRA 1 KG



Linea: H510
Clave: LA-2004

LIMPIADOR LIMPIA-MET BLANCO 1 LT



Linea: H024
Clave: SH-0001

SHAMPOO PARA INSTALACION DE PELICULA NEUTRO 500 ML

Varios, misceláneos



Linea: H654
Clave: PV-1710

POLVO DE ESMERIL # 60 POR KILO



Linea: H654
Clave: PV-1711

PIEDRA DE ESMERIL PARA MATAR FILOS



Linea: H782
Clave: SS-0000

SILICA GEL GRANULADA PARA EVITAR HUMEDAD 1 KG



Linea: H830
Clave: YP-0000

YESO PIEDRA COLOR BLANCO BOLSA DE 1 KG

ComDublin HERRAJES PARA ALUMINIO Y CRISTAL TEMPLADO

Matriz

Víctor Hugo 144, col. Portales Norte,
Del. Benito Juárez, CDMX c.p.03303
Tel. (55) 25 95 61 25
Tel. (55) 79 88 28 87
info@comdublin.com.mx

Acapulco

Artículo 27 #2 Local 3
Col. Progreso Acapulco de Juárez
Guerrero c.p. 39350
Tel. (744) 485 15 23
Tel. (744) 486 15 12
Tel. (744) 588 42 00
acapulco@comdublin.com.mx

Aguascalientes

Av. Convención de 1914 No. 1124
lote 1 entre Cavilla y España,
C.P. 20210 Col. España
Aguascalientes, Ags.
Tel. (449) 140 60 03
Tel. (449) 105 05 41
aguascalientes@comdublin.com.mx

Atizapán

amapola #1 mz.121 lt.18 local4 col.
lomas de san miguel, sur Atizapán de
Zaragoza edo. Mex c.p. 52928
Tel. (55) 58 19 83 71 (55) 58 19 82 58
Tel. (55) 28 93 03 79
atizapan@comdublin.com.mx

Av. Central

Av central 177 mz 2 lt. 16 y 17 v.
Iguala y v.guadiana col. Valle de
aragon 3ra seccion c.p. 55280
Tel. (55) 25 80 76 23
Tel. (55) 39 34 92 05
avcentral@comdublin.com.mx

Boca del Río

Av. Ejercito Mexicano Oriente
#278 Local 17 Col. Ejido Primero
de Mayo Norte Boca del Río,
Veracruz c.p. 94297
Tel. (229) 927 30 44
Tel. (229) 153 57 26
bocadelrio@comdublin.com.mx

Cancún

Av. Jose López portillo mz. 21 lt 9
región 94, Cancún
Quintana Roo c.p.77517
Tel. (998) 267 20 06
Tel. (55) 23 30 68 23
cancun@comdublin.com.mx

Centenario

Av. Centenario #1974 Local A
Col. Azcapotzalco
Alcaldía Gustavo A. Madero
CDMX c.p.07040
Tel. (55) 57 53 43 94 (55) 57 53 04 42
Tel. (55) 38 77 50 63
centenario@comdublin.com.mx

Cuajimalpa

Av. Jose Maria Castorena 46-E
col. El Molinito Cuajimalpa
Ciudad de Mexico
C.P. 05240-CR -05501
Tel. (55) 50 84 94 58
Tel. (55) 34 23 56 45
cuajimalpa@comdublin.com.mx

Cuautla

Carrt. México Oaxaca 200
Col. Gabriel Tepepa
Cuautla, Morelos c.p. 67242
Tel. (735) 352 72 72
Tel. (735) 354 10 24
Tel. (55) 39 24 82 54 (735) 246 18 62
cuautla@comdublin.com.mx

Cuernavaca

Av. Emiliano Zapata #513 B
Col. Tlaltenango Cuernavaca,
Morelos c.p. 62170
Tel. (777) 10 20 452
Tel. (777) 31 36 277
Tel. (777) 538 54 04
cuernavaca@comdublin.com.mx

División

Av. División del Norte #2655
Col. del Carmen
Alcaldía Coyoacán
CDMX c.p. 04100
Tel. (55) 56 58 83 19
Tel. (55) 56 58 83 15
Tel. (55) 20 93 25 63
division@comdublin.com.mx

Ecatepec

Av. Jose López Portillo km. 35.5
Col. Guadalupe Victoria
Ecatepec de Morelos
Edo. de México c.p. 55010
Tel. (55) 59 10 30 64
Tel. (55) 21 20 15 29
Tel. (55) 15 03 28 79
ecatepec@comdublin.com.mx

León

Bldv. Hermanos Aldama #807
Local 5 Col. San Nicolás León,
Guanajuato c.p. 37480
Tel. (477) 711 01 95
Tel. (477) 117 87 32
leon@comdublin.com.mx

Mérida

Av. Jacinto Canek #703 Int. 14
por 112 y 114 Col. Bojorquez Merida
Yucatán c.p. 97230
Tel. (999) 920 21 32
Tel. (999) 920 27 49
Tel. (55) 61 73 03 60
merida@comdublin.com.mx

Naucalpan

Calle 3 No. 47 Local 7
Col. Fracc. Industrial
Naucalpan Naucalpan
Edo. de México c.p 53370
Tel. (55) 53 57 29 28
Tel. (55) 53 57 05 31
Tel. (55) 58 26 89 25
naucalpan@comdublin.com.mx

Querétaro

Dr. Jose Maria Vertiz #12
Col. Alameda Querétaro, Querétaro
c.p. 76040
Tel. (442) 212 65 09
Tel. (55) 16 45 30 54
queretaro@comdublin.com.mx

Saltillo

Calle mariano matamoros 598-A
zona centro, Saltillo, Coahuila
c.p. 25000
Tel. (844) 48 16 123
Tel. (844) 48 15 523
Tel. (844) 58 51 772
saltillo@comdublin.com.mx

Tláhuac

Av. Tláhuac #3684 Local B
Col. Culhuacán
Alcaldía Iztapalapa
CDMX c.p. 09800
Tel. (55) 56 07 90 98
Tel. (55) 59 03 93 68
tlahuac@comdublin.com.mx

Tlalnepantla

Av. Gustavo Baz #242
Col. Miguel Hidalgo Tlalnepantla,
Edo. de México c.p. 54060
Tel. (55) 53 65 72 98
Tel. (55) 53 62 61 08
Tel. (55) 17 68 65 46
tlalnepantla@comdublin.com.mx

Toluca

Felipe Berriozabal 203-C
entre Av. Gustavo Baz y Salvador
Sánchez Colín Col. Valle Verde
Toluca, Edo. de México c.p. 50140
Tel. (722) 212 25 48
Tel. (722) 212 27 61
Tel. (551) 830 60 68
toluca@comdublin.com.mx

Tuxtla

Av. Central Poniente No 1123-A
Col. Las Canoítas Tuxtla Gutiérrez
Chiapas c.p. 29000
Tel. (961) 612 64 03
Tel. (961) 612 6415
Tel. (961) 451 53 87
tuxtla@comdublin.com.mx

Veracruz

Av. Cuahtémoc #3665 Bis
Col. Centro Veracruz, Veracruz
c.p. 91700
Tel. (229) 93 84 713
Tel. (55) 73 76 87 26
veracruz@comdublin.com.mx

Villahermosa

Niños Héroes #216 Col. Atasta
Villahermosa, Tabasco
c.p. 86100
Tel. (993) 354 87 29
Tel. (993) 210 37 77
villahermosa@comdublin.com.mx



www.comdublin.com.mx